



## Product Specifications sheet SH Series



A hydraulic thruster system is the natural choice when extensive thruster usage or long run cycles are required. We design our hydraulic systems with the style needed for pleasure craft and the reliability necessary for commercial use.

For many vessels, a hydraulic system offers an economic advantage because of the possibility to run several systems onboard from a centralized hydraulic power source. This will save cost on the individual components so that the complete package ends up with a more favorable cost compared to running all items with individual DC electric motors. Equipment that is often powered by a centralized hydraulic system includes windlasses, stabilizers, winches, cranes, furling systems and lifting mechanisms. There are many different ways of designing hydraulic systems, and some solutions are better for specific applications than others. Side-Power hydraulic systems are designed to provide outstanding performance and flexibility to efficiently support any on-board hydraulic equipment that it makes sense to power from a centralized hydraulic system.

With the SH series you get all the important and unique Side-Power features and qualities - why settle for less!

### Declaration of Conformity

We, Sleipner Motor AS hereby Declare that following Side-Power SH thruster products complies with the EC Directives and Standards:

Directive 2013/53/EU Recreational Craft Directive Directive 2006/42/EC Machinery Safety		
SH Series	2006/42 Machinery safety	EN 1037:1995+A1:2008
Gearleg	2006/42 Machinery safety	EN 1037:1995+A1:2008

Fredrikstad 14th of February 2017

Arne K Skauen  
Managing Director, Sleipner Motor AS

### Technical specifications

- Motor:** Hydraulic type
- Gear house:** Seawater resistant bronze
- Gears:** Hardened precision gears
- Lubrication:** Oil bath from tank (gear oil EP 90)
- Bearings:** Angular contact ball bearing at propellershaft and combination of ball bearing and needle bearing at driveshaft.
- Material:** Seawater resistant bronze, protected with anode
- Motor bracket:** Seawaterresistant aluminium
- Tunnel:** Cross spun with rowing G.R.P tunnel  
Steel & aluminum tunnels available at request.
- Propellers:** Symmetrical 4 blade kaplan propeller, fibreglass reinforced composite. Or, 5-blade skew "Q-PROP"
- Control panel:** Not supplied as standard
- Safety:** Flexible coupling between hydraulic-motor and driveshaft protects gearsystem if propeller gets jammed.

### Description of product/article number

#### SH xxx / xxx TC-X

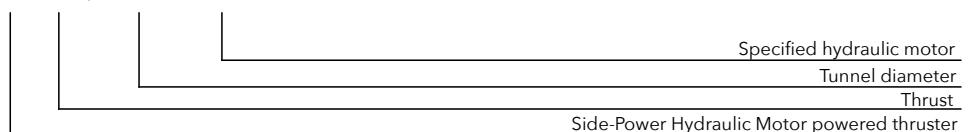



## Technical specifications and measurements

- Actual performances will vary for each installation depending on many factors.
- Specifications shown here are based on a thruster installed at a depth equal to one tunnel diameter and with Hydraulic powered thruster as shown.



### SH 100/185 T



Light duty thrust up to (kg • lbs)	100 • 220
Heavy duty thrust up to (kg • lbs)	80 • 176
Typical boat size (ft • m)	30' - 34' • 9 - 16
Tunnel I.D. (mm • in)	185 • 7.28"
Propulsion system	Twin
Hydraulic power up to (kw • Hp)	6.9 • 9.3
Weight* (kg • lbs)	9.0 • 19.8
Item Code	SH100/185T-xxx

#### Measurements

A (mm • in)	185 • 7.28
B (mm • in)	195 • 7.64
B max. (mm • in)	212 • 8.34
C min. (mm • in)	200 • 7.87
D (mm • in)	170 • 6.70
D recommended (mm • in)	340 • 13.4
E min. (mm • in)	6 • 0.24
E max. (mm • in)	8 • 0.31

#### Stern Thrusters

F (mm•in)	172•76.72
G (mm•in)	256•10.08
C min. (mm•in)	150•5.91
H max. (mm•in)	35•1.38
Tunnel length (mm•in)	337•13.27
Item code:	
Stern thruster kit	90086i
Cowls - short model	90075
Cowls - long model	90077



### SH 160/215 T



Light duty thrust up to (kg • lbs)	160 • 352
Heavy duty thrust up to (kg • lbs)	140 • 308
Typical boat size (ft • m)	35' - 62' • 11 - 19
Tunnel I.D. (mm • in)	215 • 8.46"
Propulsion system	Twin
Hydraulic power up to (kw • Hp)	10.0 • 13.4
Weight* (kg • lbs)	10.5 • 23
Item Code	SH160/215T-xxx

#### Measurements

A (mm • in)	215 • 8.46
B (mm • in)	195 • 7.64
B max. (mm • in)	230 • 9.05
C min. (mm • in)	215 • 8.5
D (mm • in)	280 • 11
D recommended (mm • in)	560 • 22
E min. (mm • in)	6 • 0.24
E max. (mm • in)	8 • 0.31

#### Stern Thrusters

F (mm•in)	172•76.72
G (mm•in)	300•11.8
C min. (mm•in)	215•8.46
H max. (mm•in)	54•2.13
Tunnel length (mm•in)	280•11
Item code:	
Stern thruster kit	90135i
Cowls	90136



### SH 240/250 TC



Light duty thrust up to (kg • lbs)	240 • 528
Heavy duty thrust up to (kg • lbs)	220 • 440
Typical boat size (ft • m)	42' - 75' • 13 - 23
Tunnel I.D. (mm • in)	250 • 9.8"
Propulsion system	Twin Counter rot.
Hydraulic power up to (kw • Hp)	14.9 • 20.0
Weight* (kg • lbs)	15.9 • 35.0
Item Code	SH240/250TC-xxx

#### Measurements

A (mm • in)	250 • 9.84
B (mm • in)	213 • 8.38
B max. (mm • in)	230 • 9.05
C min. (mm • in)	230 • 9.0
D (mm • in)	280 • 11
D recommended (mm • in)	560 • 22
E min. (mm • in)	7 • 0.28
E max. (mm • in)	10 • 0.39

#### Stern Thrusters

F (mm•in)	91•7.52
G (mm•in)	340•13.39
C min. (mm•in)	250•9.84
H max. (mm•in)	60•2.36
Tunnel length (mm•in)	350•13.78
Item code:	
Stern thruster kit	90140i
Cowls	90132



### SP 300 HYD



Light duty thrust up to (kg • lbs)	300 • 660
Heavy duty thrust up to (kg • lbs)	270 • 594
Typical boat size (ft • m)	55' - 100' • 17 - 31
Tunnel I.D. (mm • in)	300 • 11.8"
Propulsion system	Twin Counter rot.
Hydraulic power up to (kw • Hp)	17.4 • 23.3
Weight* (kg • lbs)	19.5 • 42.9
Item Code	SP300HYD-xxx

#### Measurements

A (mm • in)	300 • 11.81
B (mm • in)	220 • 8.66
B max. (mm • in)	244 • 9.61
C min. (mm • in)	300 • 11.81
D (mm • in)	300 • 11.81
D recommended (mm • in)	600 • 23.6
E min. (mm • in)	10 • 0.39
E max. (mm • in)	10 • 0.39

#### Stern Thrusters

F (mm•in)	195•7.68
G (mm•in)	420•16.54
C min. (mm•in)	300•11.81
H max. (mm•in)	60•2.36
Tunnel length (mm•in)	456•17.95
Item code:	
Stern thruster kit	90200i
Cowls	90220

COMING SOON



### SH 350/300 TC



Light duty thrust up to (kg • lbs)	350 • 771
Heavy duty thrust up to (kg • lbs)	350 • 771
Typical boat size (ft • m)	60' - 120' • 18 - 36
Tunnel I.D. (mm • in)	300 • 11.8"
Propulsion system	Twin Counter rot.
Hydraulic power up to (kw • Hp)	21.2 • 28.4
Weight* (kg • lbs)	40± • 88.2
Item Code	SH350/300TC-xxx

#### Measurements

A (mm • in)	300 • 11.81
B (mm • in)	250 • 9.84
B max. (mm • in)	300 • 11.81
C min. (mm • in)	350 • 13.78
D (mm • in)	370 • 14.57
D recommended (mm • in)	720 • 28.35
E min. (mm • in)	10 • 0.39
E max. (mm • in)	10 • 0.39

#### Stern Thrusters

F (mm•in)	225•8.86
G (mm•in)	340•13.39
C min. (mm•in)	350•13.78
H max. (mm•in)	60•2.36
Tunnel length (mm•in)	350•13.78
Item code:	
Stern thruster kit	90200i
Cowls	90220

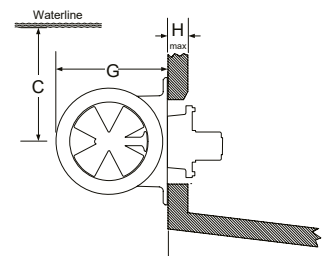
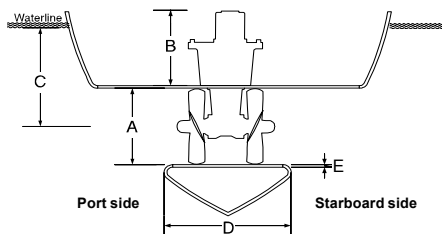
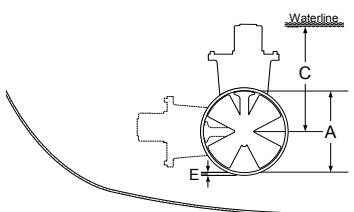

Confidence by Control

SIDE-POWER.com



## Technical specifications and measurements

- Actual performances will vary for each installation depending on many factors.
- Specifications shown here are based on a thruster installed at a depth equal to one tunnel diameter and with Hydraulic powered thruster as shown.



### SH 420/386 TC



Light duty thrust up to (kg • lbs)	420 • 925
Heavy duty thrust up to (kg • lbs)	380 • 835
Typical boat size (ft • m)	75 - 110' • 22 - 35
Tunnel I.D. (mm • in)	386 • 15.2"
Propulsion system	Twin Counter rot.
Hydraulic power up to (kw • Hp)	31.8 • 42.6
Weight* (kg • lbs)	51.8 • 114.2
Item Code	SH420/386TC-xxx

#### Measurements

A (mm • in)	386 • 15.2
B (mm • in)	292 • 11.5
B max. (mm • in)	372 • 14.65
C min. (mm • in)	380 • 15.0
D (mm • in)	500 • 19.7
D recommended (mm • in)	750 • 29.5
E min. (mm • in)	10 • 0.39
E max. (mm • in)	15 • 0.59

#### Stern Thrusters

F (mm•in)	257•10.12
G (mm•in)	540•21.25
C min. (mm•in)	380•15.00
H max. (mm•in)	
Tunnel length (mm•in)	550•21.65

#### Item code:

Stern thruster kit	90550
Cowls	90560



### SH 550/386 TC



Light duty thrust up to (kg • lbs)	550 • 1210
Heavy duty thrust up to (kg • lbs)	500 • 1100
Typical boat size (ft • m)	85 - 140' • 25 - 40
Tunnel I.D. (mm • in)	386 • 15.2"
Propulsion system	Twin Counter rot.
Hydraulic power up to (kw • Hp)	39.9 • 53.5
Weight* (kg • lbs)	52.6 • 115.7
Item Code	SH550/386TC-xxx

#### Measurements

A (mm • in)	386 • 15.2
B (mm • in)	292 • 11.5
B max. (mm • in)	372 • 14.65
C min. (mm • in)	380 • 15.0
D (mm • in)	500 • 19.7
D recommended (mm • in)	750 • 29.5
E min. (mm • in)	10 • 0.39
E max. (mm • in)	15 • 0.59

#### Stern Thrusters

F (mm•in)	257•10.12
G (mm•in)	540•21.25
C min. (mm•in)	380•15.00
H max. (mm•in)	
Tunnel length (mm•in)	550•21.65

#### Item code:

Stern thruster kit	90550
Cowls	90560

COMING SOON



### SH 700/412 TC



Light duty thrust up to (kg • lbs)	700 • 1543
Heavy duty thrust up to (kg • lbs)	700 • 1543
Typical boat size (ft • m)	95 - 145' • 29 - 44
Tunnel I.D. (mm • in)	412 • 16.2"
Propulsion system	Twin Counter rot.
Hydraulic power up to (kw • Hp)	43.4 • 58.2
Weight* (kg • lbs)	70 • 154.3
Item Code	SH700/412TC-xxx

#### Measurements

A (mm • in)	412 • 16.2
B (mm • in)	372 • 14.65
B max. (mm • in)	450 • 17.72
C min. (mm • in)	412 • 16.2
D (mm • in)	520 • 20.47
D recommended (mm • in)	770 • 30.3
E min. (mm • in)	12 • 0.47
E max. (mm • in)	16 • 0.63

#### Stern Thrusters

F (mm•in)	n. a.
G (mm•in)	n. a.
C min. (mm•in)	n. a.
H max. (mm•in)	n. a.
Tunnel length (mm•in)	n. a.

#### Item code:

Stern thruster kit	n. a.
--------------------	-------



### SH 1000/513 TC



Thrust up to (kg • lbs)	1000 • 2205
Typical boat size (ft • m)	100 - 150' • 30 - 45
Tunnel I.D. (mm • in)	513 • 20"
Propulsion system	Twin Counter rot.
Hydraulic power up to (kw • Hp)	59.8 • 80.2
Weight <sup>1</sup> (kg • lbs)	146.5 • 323
Item Code	SH1000/513TC-xxx

#### Measurements

A (mm • in)	513 • 20.2
B (mm • in)	483 • 19.1
C min. (mm • in)	700 • 27.6
D (mm • in)	850 • 33.5
D recommended (mm • in)	1000 • 39.4
E recommended <sup>2</sup> (mm • in)	16 • 0.63
E min/max. <sup>3</sup> (mm • in)	12/22 • 0.47/0.87

#### Stern Thrusters

F (mm•in)	365•14.4
G (mm•in)	726•28.6
C min. (mm•in)	770•30.3
H max. (mm•in)	
Tunnel length (mm•in)	950•37.4

#### Item code:

Stern thruster kit	91000
--------------------	-------



### SH 1400/610 TC



Thrust up to (kg • lbs)	1400 • 3085
Typical boat size (ft • m)	130 - 175' • 40 - 55
Tunnel I.D. (mm • in)	610 • 24"
Propulsion system	Twin Counter rot.
Hydraulic power up to (kw • Hp)	80.1 • 107.4
Weight <sup>1</sup> (kg • lbs)	170 • 375
Item Code	SH1400/610TC-xxx

#### Measurements

A (mm • in)	610 • 24
B (mm • in)	500 • 19.1
C min. (mm • in)	830 • 32.7
D (mm • in)	850 • 33.5
D recommended (mm • in)	1000 • 39.4
E recommended <sup>2</sup> (mm • in)	18 • 0.71
E min/max. <sup>3</sup> (mm • in)	14/24 • 0.55/0.94

#### Stern Thrusters

F (mm•in)	380•15.0
G (mm•in)	851•33.5
C min. (mm•in)	915•36.0
H max. (mm•in)	
Tunnel length (mm•in)	1000•39.4

#### Item code:

Stern thruster kit	91400
--------------------	-------

<sup>1</sup> Weight stated include thruster, props & bellhousing ONLY.  
Weight of hydraulic motor (typical 25 - 40 kg) comes in addition

<sup>2</sup> E recommended.: wall thickness of a standard Side-Power tunnel  
<sup>3</sup> E min/max: minimum/maximum wall thickness when using other GRP, steel or aluminium tunnels

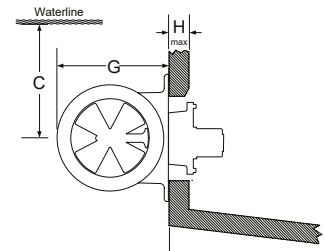
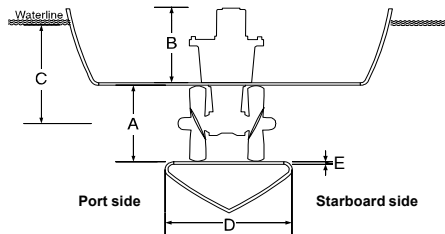
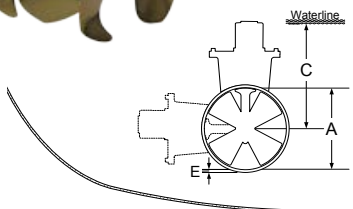

Confidence by Control

SIDE-POWER.com



## Hydraulic motor and Performance data

Thruster model	Motor type		60 %		80 %		100 % or max thrust		
			Flow	Pressure	Flow	Pressure	Flow	Pressure	
<b>SH100</b>	U6	L/min -Bar	18,8	103	21,7	137	24,2	172	
		USG-PSI	5.0	1494	5.7	1987	6.4	2494	
	U8	L/min -Bar	25,5	77	29,9	103	32,3	129	
		USG-PSI	6.6	1117	7.6	1494	8.5	1871	
	U10	L/min -Bar	31,3	62	36,1	82	40,4	103	
		USG-PSI	8.3	899	9.5	1189	10.7	1494	
<b>SH160</b>	U6	L/min -Bar	18,6	150	21,5	200	24	250	
		USG-PSI	4.9	2175	5.7	2900	6.3	3625	
	U8	L/min -Bar	24,8	112	28,6	150	32,0	187	
		USG-PSI	6.6	1624	7.6	2175	8.5	2712	
	U10	L/min -Bar	31,0	82	35,8	120	40,0	150	
		USG-PSI	8.2	1305	9.5	1740	10.6	2172	
	U11	L/min -Bar	34,1	82	39,3	109	44,0	136	
		USG-PSI	9.0	1189	10.4	1581	11.6	1972	
	U14	L/min -Bar	43,1	64	49,7	86	55,6	107	
		USG-PSI	11.4	928	13.1	1247	14.7	1552	
	<b>SH240</b>	U8	L/min -Bar	19,1	217			21,3 <sup>1)</sup>	272 <sup>1)</sup>
			USG-PSI	5.0	3147			5.6 <sup>1)</sup>	3944 <sup>1)</sup>
U10		L/min -Bar	23,8	174	27,5	232	28,5 <sup>2)</sup>	240 <sup>2)</sup>	
		USG-PSI	6.3	2523	7.3	3364	7.5 <sup>2)</sup>	3480 <sup>2)</sup>	
U11		L/min -Bar	26,2	158	30,2	211	33,8	264	
		USG-PSI	6.9	2291	8.0	3060	8.9	3828	
U14		L/min -Bar	33,1	124	38,2	166	42,7	207	
		USG-PSI	8.7	1798	10.1	2407	11.3	3002	
U16		L/min -Bar	38,1	109	44,0	145	49,2	181	
		USG-PSI	10.1	1581	11.6	2103	13.0	2625	
U19		L/min -Bar	45,1	92	52,1	122	58,3	153	
		USG-PSI	11.9	1334	13.8	1769	15.4	2219	
<b>SP300HYD</b>	U10	L/min -Bar	20	243			20,0 <sup>3)</sup>	243 <sup>3)</sup>	
		USG-PSI	5.3	3224			5.3 <sup>3)</sup>	3524 <sup>3)</sup>	
	U11	L/min -Bar	22,0	221			24,6 <sup>4)</sup>	276 <sup>4)</sup>	
		USG-PSI	5.8	3205			6.5 <sup>4)</sup>	4002 <sup>4)</sup>	
	U14	L/min -Bar	27,8	173	32,1	231	35,0 <sup>5)</sup>	275 <sup>5)</sup>	
		USG-PSI	7.3	2509	8.5	3350	9.2 <sup>5)</sup>	3988 <sup>5)</sup>	
	U16	L/min -Bar	32,0	152	36,9	202	41,3	253	
		USG-PSI	8.5	2204	9.7	2929	10.9	3669	
	U19	L/min -Bar	37,9	128	43,7	170	48,9	213	
		USG-PSI	10.0	1856	11.5	2465	12.9	3089	

<sup>1)</sup> Max. thrust: 165kg

<sup>2)</sup> Max. thrust: 189kg

<sup>3)</sup> Max. thrust: 180kg

<sup>4)</sup> Max. thrust: 225kg

<sup>5)</sup> Max. thrust: 285kg

Thruster model	Motor type		60 %		80 %		100 % or max thrust	
			Flow	Pressure	Flow	Pressure	Flow	Pressure
<b>SH420</b>	U26	L/min -Bar	45,8	188	52,8	251	57,3	295 <sup>6)</sup>
		USG-PSI	12,1	2726	14	3640	15,1	4278
	U29	L/min -Bar	51,0	169,0	58,9	225	65,9	281
		USG-PSI	13,5	2451	15,6	3263	17,5	4075
	U33	L/min -Bar	58,1	148	67,1	198	75,0	247
		USG-PSI	15,5	2146	17,7	2871	19,8	3582
	U37	L/min -Bar	65,1	132	75,2	176	84,1	220
		USG-PSI	17,2	1914	19,9	2552	22,2	3190
	BA40	L/min -Bar	61,0	121	70,4	161	78,7	202
		USG-PSI	16,1	1754	19,6	2335	20,8	2929
	P42	L/min -Bar	73,6	116	84,9	155	95,0	194
		USG-PSI	19,4	1682	22,4	2248	25,1	2813
G45	L/min -Bar	79,2	109	91,4	145	102,2	181	
	USG-PSI	21	1580	24,2	2103	27	2625	
BA45	L/min -Bar	68,0	106	78,5	142	87,8	177	
	USG-PSI	18	1537	20,7	2059	23,2	2567	
<b>SH550</b>	U37	L/min -Bar	74,5	173	86,0	231	93,8	274 <sup>7)</sup>
		USG-PSI	19,7	2509	22,7	3350	24,8	3974
	BA40	L/min -Bar	69,8	158	80,5	211	90,0	264
		USG-PSI	18,4	2291	21,3	3060	23,8	3829
	P42	L/min -Bar	84,2	152	97,2	203	108,7	254
		USG-PSI	22,2	2204	25,7	2944	28,7	3683
	G45	L/min -Bar	90,6	142	104,6	190	117,0	237
		USG-PSI	24	2059	27,6	2755	31	3437
	BA45	L/min -Bar	77,8	139	89,9	185	100,5	232
		USG-PSI	20,6	2016	23,8	2683	26,6	3364
	U50	L/min -Bar	101,1	128	116,7	171	130,5	213
		USG-PSI	26,7	1856	30,8	2480	34,5	3089
P52	L/min -Bar	105,1	124	121,4	166	135,7	207	
	USG-PSI	27,8	1798	32,1	2407	35,9	3002	
BA60	L/min -Bar	104,6	106	120,8	141	135,1	176	
	USG-PSI	27,6	1537	32	2045	35,7	2552	

<sup>6)</sup> Max. thrust: 347kg

<sup>7)</sup> Max. thrust: 386kg





## Hydraulic motor and Performance data

			60 %		70 %		80 %		90 %		100 %	
			Flow	Pressure	Flow	Pressure	Flow	Pressure	Flow	Pressure	Flow	Pressure
<b>SH1000</b>	G70	L/min -Bar	91,0	220	99,0	256						
		USG-PSI	24.0	3190	26.2	3712						
	G75	L/min -Bar	98,0	205	106,0	239						
		USG-PSI	25.9	2973	28.0	3466						
	BA80	L/min -Bar	90,4	188	98,0	220	104,4	251	111,0	282		
		USG-PSI	23.9	2726	25.9	3190	27.6	3640	29.3	4089		
	BA90	L/min -Bar	99,5	167	107,0	195	115,0	225	122,0	251	128,5	279
		USG-PSI	26.3	2422	28.3	2828	30.4	3263	32.2	3640	40.0	4046
BA110	L/min -Bar	122,0	139	131,4	132	140,5	185	149,0	208	157,0	231	
	USG-PSI	32.2	2016	34.7	1914	37,1	2683	39.4	3016	41.5	3350	
<b>SH1400</b>	BA125	L/min -Bar	113,0	197	122,4	230	131,0	263	139,0	296		
		USG-PSI	29.9	2857	32.3	3335	34.6	3814	36.7	4292		
	BA150	L/min -Bar	139,0	164	150,0	192	160,4	219	170,0	247	179,4	274
		USG-PSI	36.7	2378	39.6	2784	42.4	3176	44.9	3582	47.4	3973
	BA160	L/min -Bar	145,0	154	157,0	180	167,5	205	178,0	231	187,0	257
		USG-PSI	38.3	2233	41.5	2610	44.3	2973	47.0	3350	49.4	3727
	BA180	L/min -Bar	163,0	137	176,0	160	188,5	183	200,0	205	211,0	228
		USG-PSI	43.0	1987	46.5	2320	49.8	2654	52.8	2973	55.7	3306

### Maintenance

- Gearleg: Oil level must be correct at all time. Change oil the first 50 hours, then every 500 hours or every 2nd year (EP90). Seasonal service should include change of anodes and checking that all bolts are tighten(motor/motor bracket - propeller). See User and Installation manual for more detailed information.
- Hydraulic motor: See User and Installation manual for more information.

### Material specifications

- Hydraulic Motor: There are no hazardous materials in this product, ref material declaration.
- Gearleg: Gear oil EP90 that needs to be kept away from fire, and general precautionary measures must be taken.

### Health and Safety

- Gearleg and Hydraulic motor: The Gearleg is shipped without gear oil - no hazard. The gearleg and Hydraulic motor is very powerful and precautionary measures must be taken considering rotating propeller. Gear oil is flameable and gasses from a fire is generally toxic.
- See Installation and User manual for more information.

*This document may contain typographical errors, to which Sleipner Motor assumes no responsibility.*



Sleipner Motor AS  
P.O. Box 519,  
N-1612 Fredrikstad, Norway  
Tel: +47 69 30 00 60  
Fax: +47 69 30 00 70  
sidepower@sleipner.no  
www.side-power.com



Confidence by Control

**SIDE-POWER.com**

# SH100/185T-U06

## SH100 Tunnel bow/stern thruster

### hydraulic U06



Spare parts (valid from 2017-12-18)

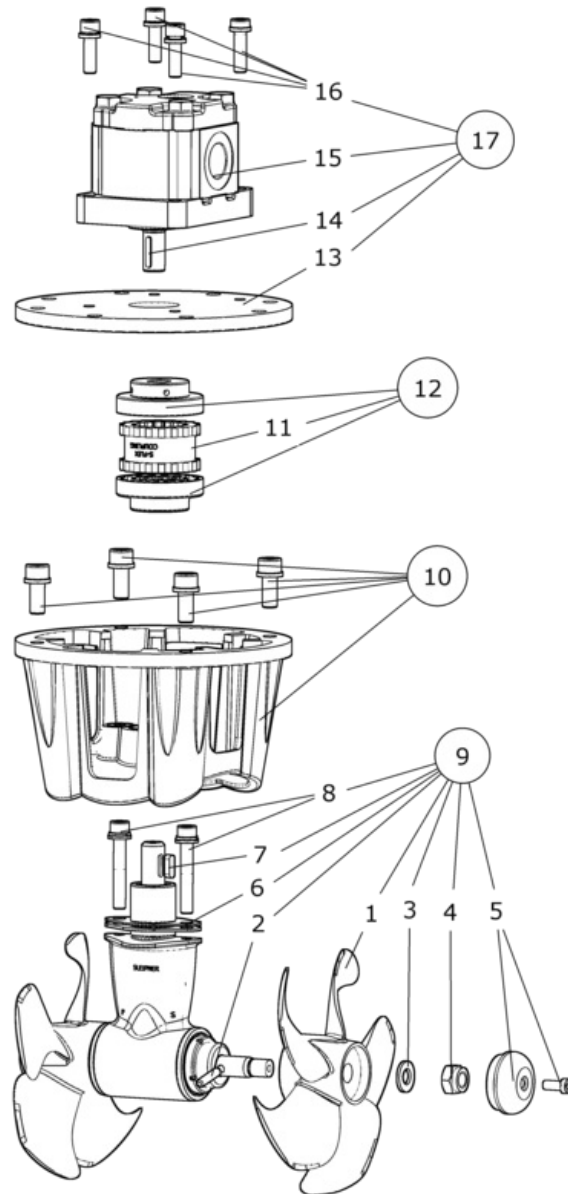

#	Name	Item Code	Description
1	Propeller	7 1261	Thruster propeller Twin Ø185 / 5 bl
2	Propeller key	6 1241	Drive pin for propeller 5mm
3	Propeller washer	7 1181	Propeller washer SE60/80/100
4	Locknut	4 1260	Lock nut
5	Anode	7 1190 A	Anode kit, aluminium for SE60/80/100
6	Gasket (between gearleg and tunnel)	8 0610	Gasket for gearleg installation in tunnel, SP75/95
7	Drive shaft key	6 1440	Key for flexible coupling 7HP/SP75/95
8	Gearleg bolt	7 1080	Bolt M8 x 55 Unbraco
9	Complete gearleg	8 0601	Complete gearleg SE80/100
10	Complete motor bracket	8 0501	Complete motor bracket SE80/100
11	Rubber element	7 1451	Rubber element for flexible coupling SP75/95
12	Complete flexible coupling	7 1450	Flexible coupling SH100
13	Adaptor plate	10 21301	Adaptor plate SH100/240
14	Drive shaft key	7 1440	Drive shaft key for hydraulic motors
15	Hyd. Motor options:		
15a	U-06(6ccm)	72100/U-06	Hydraulic motor 6ccm ultra
15b	U-08(8ccm)	72100/U-08	Hydraulic motor 8ccm ultra
15c	U-10(10ccm)	72100/U-10	Hydraulic motor 10ccm ultra
16	Hydraulic motor bolts	6 1360	Bolt M8 x 30 Unbraco
17	Hyd. Motor assembly options:		
17a	SH100HYD motor, U-06, complete	72100UL2	Hydraulic motor SH100/160-6ccm U
17b	SH100HYD motor, U-08, complete	72110UL2	Hydraulic motor U 8ccm Ultra
17c	SH100HYD motor, U-10, complete	72115UL2	Hydraulic motor U 10ccm Ultra

The installer alone has responsibility for the installation of the spare parts. Side-Power only warranty the spare parts supplied only.

The information given in the document was correct at the time it was published. However, Sleipner Motor AS can not accept liability for any inaccuracies or omissions it may contain. Continuous product improvement may change the product specifications without notice. Therefore, Sleipner Motor AS can not accept liability for any possible differences between product and document.