

SOLARPOWER™ Series. Photovoltaic Solar Panel Battery Chargers and Maintainers

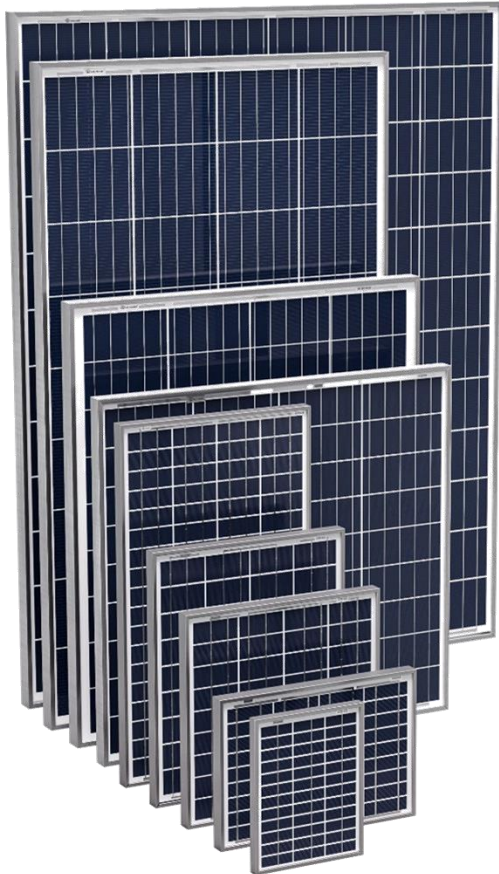

SOLARPOWER™ Series - XUNZEL

High-Efficiency Photovoltaic Solar Panel.

Specially designed for improved battery charging and maintenance.

With extra-long solar cable pre-assembled. Ready to use.

Ideal choice for professional Off-Grid, Off-Shore and Back-Up Solar Systems.

Product Overview

- Specially designed to charge **12V, 24V and 48V batteries** with maximum efficiency. Ideal for safe Off-Grid, Off-Shore and Back-up Solar Systems.
- **High-Quality materials**, reliability and excellent performance for all weather conditions.
- **Solar Cable included and pre-installed.** No need to purchase cable separately.
- Safe and Easy to install and **Ready-to-Connect** directly to the solar charge controller.
- **Thin and Lightweight.**
- Hardened protective **low iron tempered solar glass** protects the cells.
- **Marine grade anodized aluminum alloy frame**
- **Waterproof and Weatherproof.** Sealed and **Corrosion resistant** junction box to protect electrical connections.
- **Expandable.** Higher power systems can be achieved easily connecting more strings in parallel (for more current) or series (for more voltage).
- **High efficiency and quality crystalline Silicon (c-Si) Solar PV modules.**
- **Positive Tolerance.**
- **100% Individually Certified and Tested** before shipping (Flash Test + EL Test)
- **Secure Individual Packaging**, ready to ship anywhere.

Models

SOLARPOWER	5W 12V pre-installed cable 200cm
SOLARPOWER	10W 12V pre-installed cable 200cm
SOLARPOWER	15W 12V pre-installed cable 200cm
SOLARPOWER	20W 12V pre-installed cable 200cm
SOLARPOWER	20W 24V pre-installed cable 400cm + integrated bracket
SOLARPOWER	30W 12V pre-installed cable 200cm
SOLARPOWER	30W 24V pre-installed cable 400cm + integrated bracket
SOLARPOWER	60W 12V pre-installed cable 400cm
SOLARPOWER	80W 12V pre-installed cable 400cm
SOLARPOWER	120W 12V pre-installed cable 400cm
SOLARPOWER	100W 24V pre-installed cable 400cm
SOLARPOWER	185W 24V pre-installed cable 400cm
SOLARPOWER	190W 12V pre-installed cable 400cm



SOLARPOWER 5W to 30W | 12V include 2m single cable (2 core)



SOLARPOWER 60W to 190W include 4m cable (2-cable)



SOLARPOWER 20W-24V and 30W-24V with integrated bracket and 4 m. cables.

© Copyright 2022 XUNZEL™ reserves the right to make changes and improvements without prior notice. Specifications are subject to change without further notification

XU-92220226-MA

Industry Leading Technology for Off-Grid, Off-Shore and Backup Power Applications



SOLARPOWER™ Series. Photovoltaic Solar Panel Battery Chargers and Maintainers

Specifications

Model	SOLARPOWER-5W - 12V	SOLARPOWER-10W - 12V	SOLARPOWER-15W - 12V	SOLARPOWER-20W - 12V	SOLARPOWER-20W - 24V	SOLARPOWER-30W - 12V	SOLARPOWER-30W - 24V	SOLARPOWER-60W - 12V	SOLARPOWER-80W - 12V	SOLARPOWER-100W - 24V	SOLARPOWER-120W - 12V	SOLARPOWER-185W - 24V	SOLARPOWER-190W - 12V
Code Order Part Number	SOLZTK5	SOLZTK10	SOLZTK15	SOLZTK20	SOLZTK2024Y	SOLZTK30	SOLZTK3024Y	SOLZTK60	SOLZTK80	SOLZTK10024	SOLZTK120	SOLZTK185	SOLZTK190
Maximum Power P _{max} [Wp]	5	10	15	20	20	30	30	60	80	100	120	185	190
Nominal Voltage [VDC]	12	12	12	12	24	12	24	12	12	24	12	24	12
Open Circuit Voltage VOC [VDC]	21.20	21.20	22.00	21.20	43.20	22.00	43.20	20.20	23.00	44.95	22.70	47.55	23.60
Maximum Power Point Voltage VMPP [VDC]	18.00	18.00	18.70	18.00	36.00	18.70	36.00	18.70	18.30	38.31	18.30	39.79	19.58
Short-Circuit Current ISC [ADC]	0.30	0.59	0.85	1.20	0.61	1.73	0.92	3.46	4.63	2.67	6.95	4.95	9.85
Maximum Power Point Current IMPP [ADC]	0.28	0.56	0.81	1.12	0.56	1.60	0.83	3.21	4.37	2.61	6.56	4.65	9.71
Maximum System Voltage SCII [VDC]	600	600	600	600	1000	600	1000	600	1000	1000	1000	1000	1000
Dimensions (mm)	240x180x18	340x240x25	345x340x25	420x340x25	420x340x25	604x340x25	505x430x25	674x604x30	768x676x35	800x680x35	1158x676x35	1020x1000x35	1020x1000x35
Net Weight (kg)	0.60	1.00	1.40	1.60	2.00	2.20	2.80	5.10	6.70	5.80	9.30	11.80	11.80
Pre-assembled Cables (red "+" and black "-")	1 Cable (2-cores) 200cm 2x 1.00mm ² (SOLARPOWER-5W-12V, 20W-24V and 30W-24V: 2x 0.75mm ²)						2 Cables 400cm (red "+" and black "-") 2 x 4.00mm ²						
Junction Box	IP65/67												
Operating Temperature Range	-40°C ~ +85°C (-40°F ~ +185°F)												
Normal Operating Conditions Temp. (NOCT)	45 ± 2°C												
Temperature Coefficient of Power Current Voltage	- 0.35% /K + 0.05% /K - 0.27% /K												
Maximum Series Fuse Rating	12A						12A						
Maximum Reverse Current	12A						20A						
Bypass Schottky Diode	1 pc						2 pcs						
Materials	Frame: Anodized Aluminum Alloy Solar Glass: 3.2mm AR Coating Low-iron and tempered (EN 12150) Mechanical Load 5400Pa Encapsulant: Transparent EVA (Ethylene-Vinyl-Acetate) High-quality film TPT / TPE /BBF Solar Cells interconnection with hi-purity copper 99,98%												
Standards	CE UKCA RoHS3 and REACH Compliant Hg Free WEEE Compliant Manufactured and Tested according to IEC 61215 / IEC 61730 Electrical data – Specifications at Standard Test Conditions (STC): 1000W/m ² solar irradiance, AM 1.5, 25 °C cell temperature												
PLUS	SOLARPOWER 20W-24V y 30W-24V models with integrated bracket												



The design and all photos and drawings on these sheets are protected by law and may not be distributed or reproduced, in whole or in part, or published or used for any purpose without the express written consent of XUNZEL. © XUNZEL - Xunzel is not responsible for any typographical errors. Specifications subject to change without notice.

© Copyright 2022 XUNZEL™ reserves the right to make changes and improvements without prior notice. Specifications are subject to change without further notification

XU-92220226-MA

Industry Leading Technology for Off-Grid, Off-Shore and Backup Power Applications



info@xunzel.com
www.xunzel.com

© Copyright Xunzel. Information contained in this document is subject to change without notice.

SOLARPOWER™ Series. Photovoltaic Solar Panel Battery Chargers and Maintainers

Drawings (mm)

SOLARPOWER-5W-12V

Code | Order Part Number: SOLZTK5

240 x 180 x 18 mm

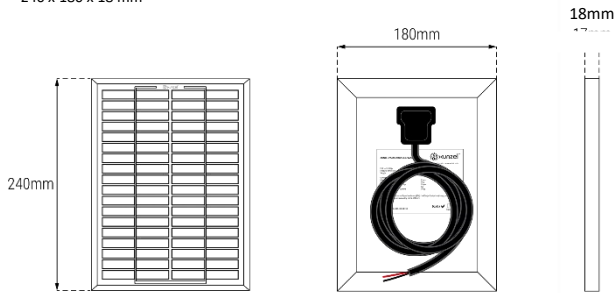

SOLARPOWER-10W-12V

Code | Order Part Number: SOLZTK10

340 x 240 x 25 mm

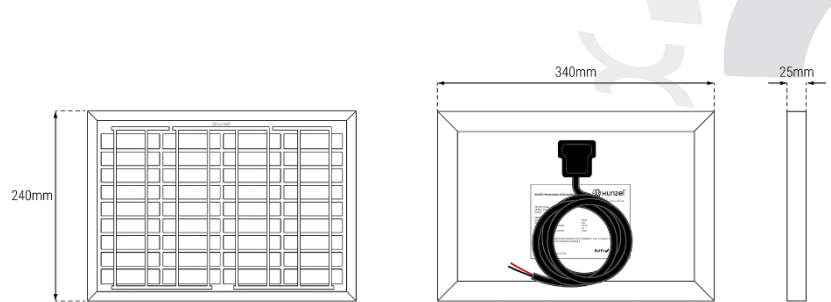

SOLARPOWER-15W-12V

Code | Order Part Number: SOLZTK15

345 x 340 x 25 mm

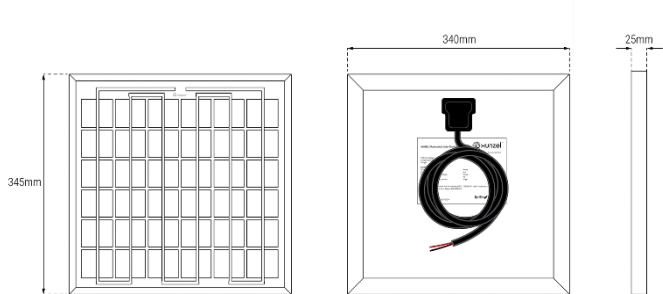

SOLARPOWER-20W-12V

Code | Order Part Number: SOLZTK20

420 x 340 x 25 mm

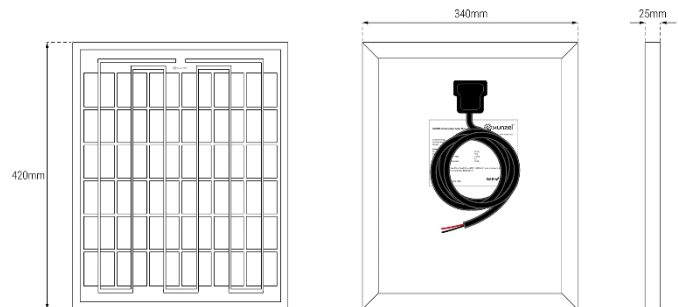

SOLARPOWER-20W-24V

Code | Order Part Number: SOLZTK2024Y

420 x 340 x 25 mm

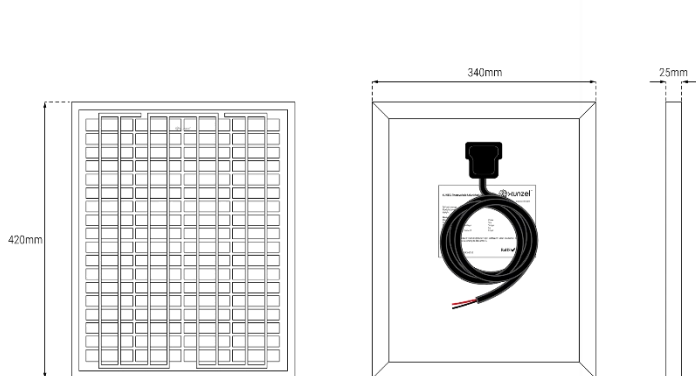

SOLARPOWER-30W-12V

Code | Order Part Number: SOLZTK30

604 x 340 x 25 mm

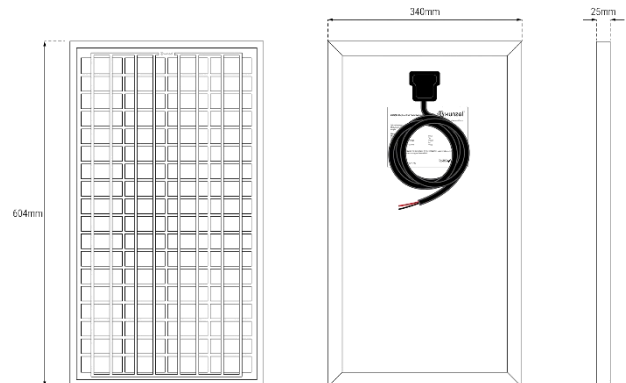

The design and all photos and drawings on these sheets are protected by law and may not be distributed or reproduced, in whole or in part, or published or used for any purpose without the express written consent of XUNZEL. © XUNZEL - Xunzel is not responsible for any typographical errors. Specifications subject to change without notice.

© Copyright 2022 XUNZEL™ reserves the right to make changes and improvements without prior notice. Specifications are subject to change without further notification. NOT IN SCALE

XU-92220226-MA

Industry Leading Technology for Off-Grid, Off-Shore and Backup Power Applications



SOLARPOWER™ Series. Photovoltaic Solar Panel Battery Chargers and Maintainers

Drawings (mm)

SOLARPOWER-30W-24V

Code | Order Part Number: SOLZTK3024V
505 x 430 x 25 mm

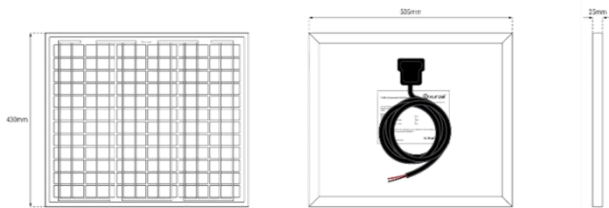

SOLARPOWER-60W-12V

Code | Order Part Number: SOLZTK60
674 x 604 x 30 mm

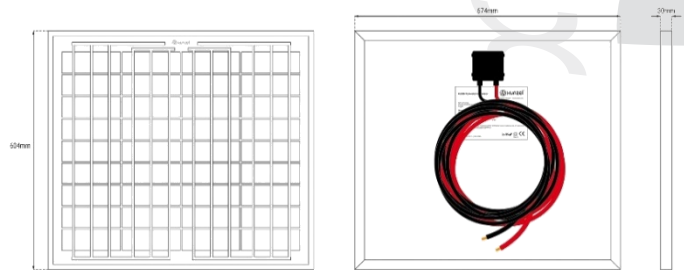

SOLARPOWER-80W-12V

Code | Order Part Number: SOLZTK80
768 x 676 x 35 mm

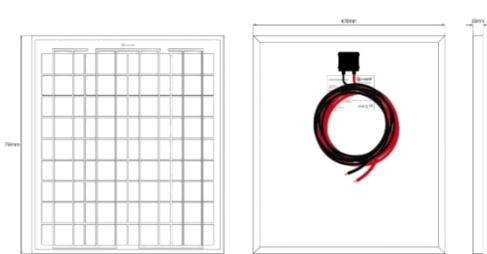

SOLARPOWER-100W-24V

Code | Order Part Number: SOLZTK10024
800 x 680 x 35 mm

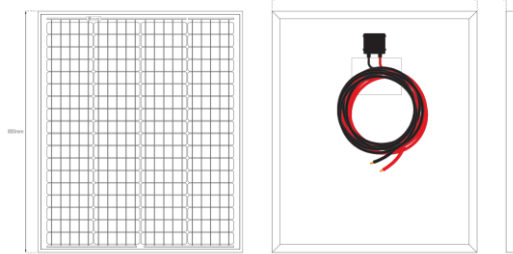

SOLARPOWER-120W-12V

Code | Order Part Number: SOLZTK120
1158 x 676 x 35 mm

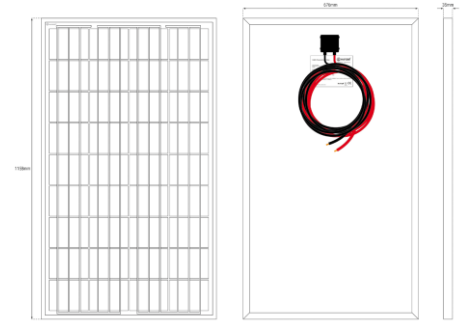

SOLARPOWER-185W-24V

Code | Order Part Number: SOLZTK185
1020 x 1000 x 35 mm

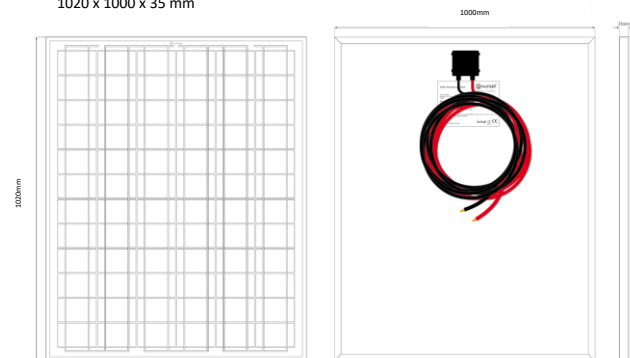

SOLARPOWER-190W-12V

Code | Order Part Number: SOLZTK190
1020 x 1000 x 35 mm

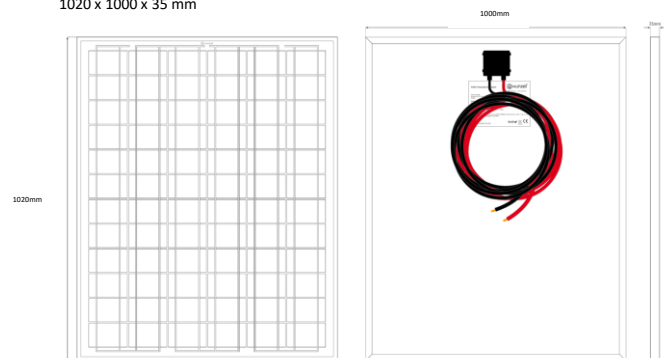

The design and all photos and drawings on these sheets are protected by law and may not be distributed or reproduced, in whole or in part, or published or used for any purpose without the express written consent of XUNZEL. © XUNZEL - Xunzel is not responsible for any typographical errors. Specifications subject to change without notice.

© Copyright 2022 XUNZEL™ reserves the right to make changes and improvements without prior notice. Specifications are subject to change without further notification. NOT IN SCALE

XU-92220226-MA

Industry Leading Technology for Off-Grid, Off-Shore and Backup Power Applications



SOLARPOWER™ Series. Photovoltaic Solar Panel Battery Chargers and Maintainers

SOLARPOWER-5W-12V

Code | Order Part Number: SOLZTK5

240 x 180 x 18 mm



SOLARPOWER-10W-12V

Code | Order Part Number: SOLZTK10

340 x 240 x 25 mm



SOLARPOWER-15W-12V

Code | Order Part Number: SOLZTK15

345 x 340 x 25 mm



SOLARPOWER-20W-12V

Code | Order Part Number: SOLZTK20

420 x 340 x 25 mm



SOLARPOWER-20W-24V

Code | Order Part Number: SOLZTK2024Y

420 x 340 x 25 mm



SOLARPOWER-30W-12V

Code | Order Part Number: SOLZTK30

604 x 340 x 25 mm



The design and all photos and drawings on these sheets are protected by law and may not be distributed or reproduced, in whole or in part, or published or used for any purpose without the express written consent of XUNZEL. © XUNZEL - Xunzel is not responsible for any typographical errors. Specifications subject to change without notice.

© Copyright 2022 XUNZEL™ reserves the right to make changes and improvements without prior notice. Specifications are subject to change without further notification. NOT IN SCALE

XU-92220226-MA

Industry Leading Technology for Off-Grid, Off-Shore and Backup Power Applications



SOLARPOWER™ Series. Photovoltaic Solar Panel Battery Chargers and Maintainers

SOLARPOWER-30W-24V

Code | Order Part Number: SOLZTK3024Y
505 x 430 x 25 mm



SOLARPOWER-60W-12V

Code | Order Part Number: SOLZTK60
674 x 604 x 30 mm



SOLARPOWER-80W-12V

Code | Order Part Number: SOLZTK80
768 x 676 x 35 mm



SOLARPOWER-100W-24V

Code | Order Part Number: SOLZTK10024
800 x 680 x 35 mm

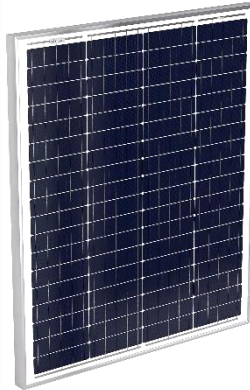

SOLARPOWER-120W-12V

Code | Order Part Number: SOLZTK120
1158 x 676 x 35 mm



SOLARPOWER-185W-24V

Code | Order Part Number: SOLZTK185
1020 x 1000 x 35 mm



SOLARPOWER-190W-12V

Code | Order Part Number: SOLZTK190
1020 x 1000 x 35 mm

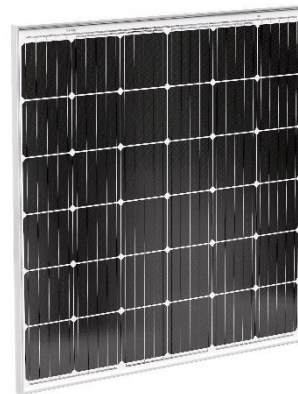

The design and all photos and drawings on these sheets are protected by law and may not be distributed or reproduced, in whole or in part, or published or used for any purpose without the express written consent of XUNZEL. © XUNZEL - Xunzel is not responsible for any typographical errors. Specifications subject to change without notice.

© Copyright 2022 XUNZEL™ reserves the right to make changes and improvements without prior notice. Specifications are subject to change without further notification. NOT IN SCALE

XU-92220226-MA

Industry Leading Technology for Off-Grid, Off-Shore and Backup Power Applications

