

SIDE-POWER
Thruster Systems

PJC221/222

S-linkControl Panel

EN Installation and user's manual v 2.1.4

Keep this
manual onboard !



PJC221



PJC222



SLEIPNER MOTOR AS

P.O. Box 519
N-1612 Fredrikstad
Norway
www.side-power.com



Made in Norway

© Sleipner Motor AS 2017

Contents

Product Features	3
Panel layout & functions	4
Display in normal use	5
symbols explanations.....	6-7
HOLD calibration	8
Menu system	9
Menu system - Language - Stabilizer - default settings	10
Setup procedure.....	11
Menu system - Setup.....	12-17
System devices	12
1. PHC 024	12
2. PHC-3	12
3. PDC 101	15
4. PDC 201	15
5. PDC 301	15
6. MAIN SWITCH	16
7. PPC520, PPC820, PPC840, PPC800, SR150 000, SR6 1242	16-17
8. RCRS-1 and RCRS-2	18
9. MSI8730	18
10. ESI-1 and GW-1	18
Hold calibration	19
Joystick calibration.....	19
Menu system - Info.....	20
Menu system - Panel Setup.....	21
Alarm system	22
Alarm descriptions	23-24
Technical specifications and measurements	25
Connections	26

DO NOT connect any other control equipment to the S-link controlled products except Side-Power original S-link products or via a Side-Power supplied interface product made for interfacing with other controls. Any attempt to directly control or at all connect into the S-link control system without the designated and approved interface, will render all warranties and responsibilities for the complete line of Side-Power products connected void and null. If you are interfacing by agreement with Sleipner and through a designated and approved interface, you are still required to also install an original Sidepower control panel to enable efficient troubleshooting if necessary

DECLARATION OF CONFORMITY



We, Sleipner Motor AS
P.O. Box 519
N-1612 Fredrikstad, Norway

declare that this product with accompanying standard remote control systems complies with the essential health and safety requirements according to the Directive 89/336/EEC of 23 May 1989 amended by 92/31/EEC and 93/68/EEC.

Control panel with S-link™ CAN-bus connection

Product features

- For proportional thruster control with DC, AC and Hydraulic Thrusters
- Finger tip control speed control with purpose designed joysticks
- Hold - function for easy docking, runs thrusters at selected power
- Back-lit LCD display with instant feedback
 - System status / alarms
 - Amount of thrust & direction of thrust
- Interactive multi-language menus
- CAN-Bus communication with thrusters and accessories
- Plug & play cables with compact connectors
- Diagnostics and system setup via panel
- Built-in audible alarm "buzzer"
- Connector for external "buzzer"/loud audible alarms
- Supports Side-Power retractable thrusters with or without Speed Control



Panel layout & functions

PJC-221

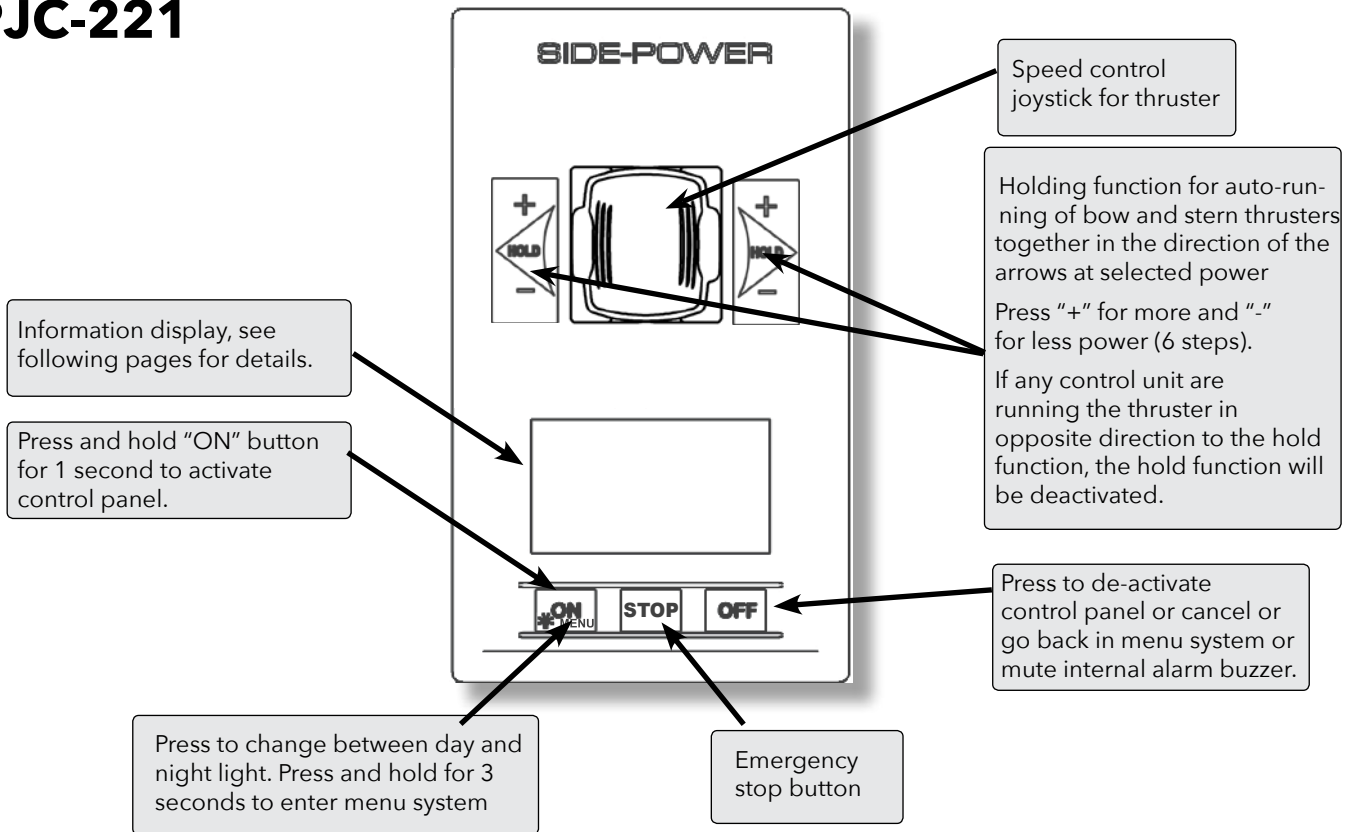

PJC-222

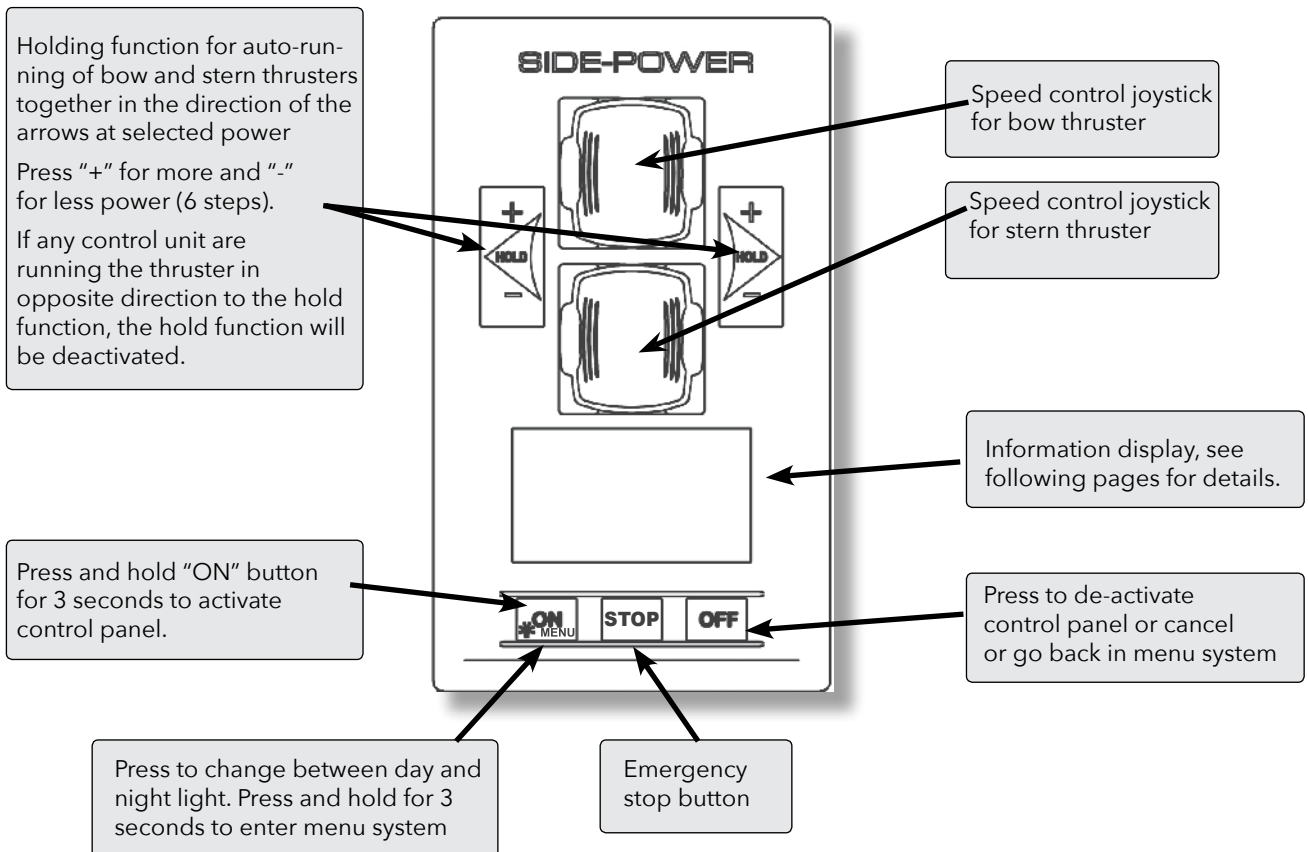

Display in normal use

Status indicators for bow thruster. (Port bow thruster in a dual bow thruster setup).

Runtime indicator will be shown here in a single DC electric bow thruster setup.

Status indicators for stern thruster. (Port bow thruster in a dual stern thruster setup)

Runtime indicator will be shown here in a single DC electric stern thruster setup.

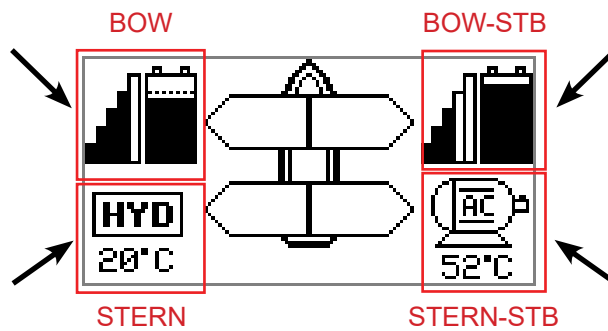

Status indicators for starboard bow thruster. Only shown in a dual bow thruster setup.

Battery indicator will be shown here in a single DC electric bow thruster setup.

Status indicators for starboard stern thruster. Only shown in a dual stern thruster setup.

Battery indicator will be shown here in a single DC electric stern thruster setup.

Examples of display view for different panels applications:

PJC221:
DC Electric Bow thruster

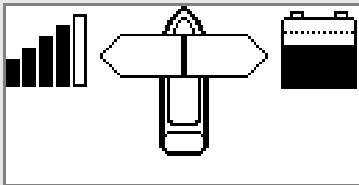

PJC221:
Hydraulic Bow thruster

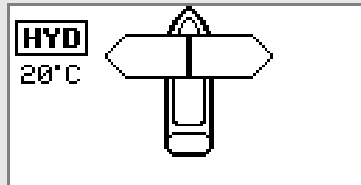

PJC221:
AC Electric Bow thruster

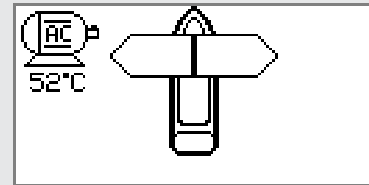

PJC221:
DC Electric Stern thruster

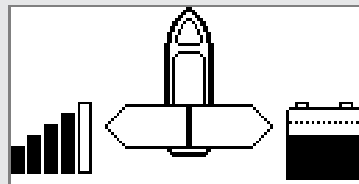

PJC221:
Dual AC Electric Bow thrusters

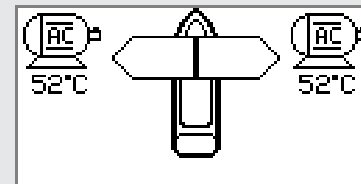

PJC221:
Dual Hydraulic Bow thrusters

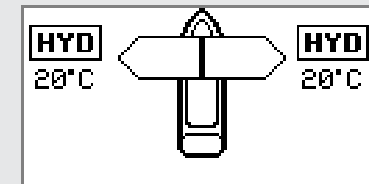

PJC222:
DC Electric Bow thruster
DC Electric Stern Thruster

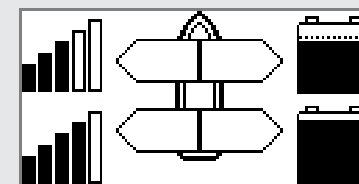

PJC222:
Hydraulic Bow thruster
Hydraulic Stern Thruster

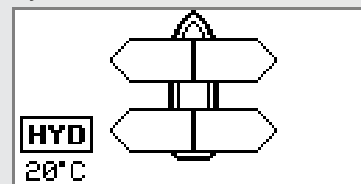

PJC222:
AC Electric Bow thruster
Hydraulic Stern Thruster

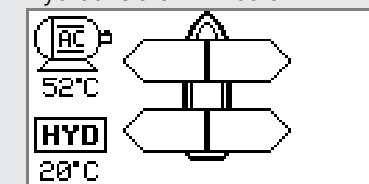

PJC222:
Dual DC Electric Bow thrusters
Dual DC Electric Stern thrusters

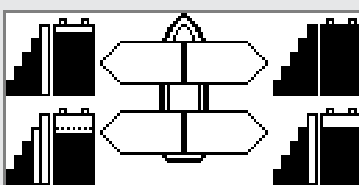

PJC222:
Dual Hydraulic Bow thrusters
Dual Hydraulic Stern thrusters

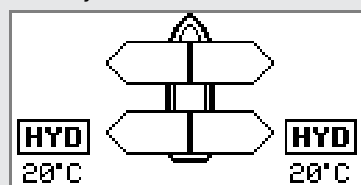

PJC222:
Dual AC Electric Bow thrusters
Dual AC Electric Bow thrusters

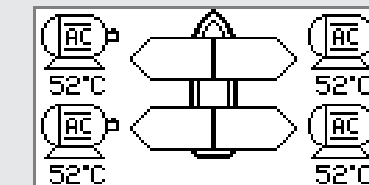

Symbols explanations

DC Thrusters:

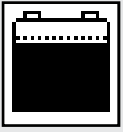

Battery indicator.
From 8.5V to 12V for 12V thrusters,
15V to 24V for 24V thrusters

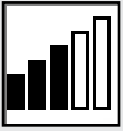

Motor temperature indicator.
From 70°C/ 158°F to 130°C/266°F.

Symbol shown when a DC Thruster is used in a dual bow or dual stern setup:

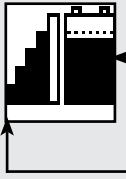

Battery indicator.
From 8.5V to 12V for 12V thrusters,
15V to 24V for 24V thrusters

Motor temperature indicator.
From 70°C/ 158°F to 130°C/266°F.

AC Thrusters:

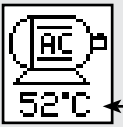

Motor temperature indicator.

Hydraulic Thrusters:



Hydraulic oil temperature indicator.

Retractable Thrusters:



Symbol shown when the thruster deploys.



Symbol shown when the thruster retracts.



Symbol shown when the thruster is in position OUT.
When the thruster is deployed and no input is given via the joysticks/buttons over a 10 second period, the panel will give an audible signal every 10th second to tell that the truster is still deployed.

Symbols explanations

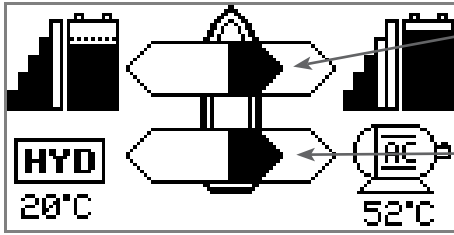

Thrust power and direction, Bow thruster(s)

Input from bow joystick on this panel.
The thrust indicator will be shown in this position on a single joystick panel if the thruster is defined as a bow thruster

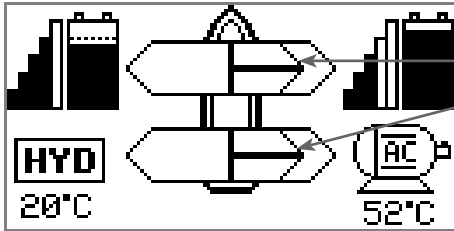

Thrust power and direction, Stern thruster(s)

Input from stern joystick on this panel
The thrust indicator will be shown in this position on a single joystick panel if the thruster is defined as a stern thruster.

Indicating amount of thrust set by other control units in the system, i.e additional PJC panels, 8700 Retract panel, input via 8730 S-link external switch interface, S-link remote control etc.

If two or more units are set to run the thruster in opposite direction, this information will not be shown.

FIRST TIME SETUP

After installation of an S-link thrusters system, a System Setup procedure to setup control panels, thrusters and additional equipment must be completed (ref. procedure on page 13) before the system can be used. Write down all the S- Link devices and serial number one page 27.

HOLD function

The 'HOLD' function is for auto-running of bow and stern thrusters together in the direction of the arrows at selected power.

Press "+" for more and "-" for less power (6 steps). The 'HOLD' function is normally used to hold the boat into the dock while mooring. The 'HOLD' function can be deactivated by running any thruster in the opposite direction from any control unit.

Calibration

The 'HOLD' function can be calibrated to get balanced thrust from the bow and stern thruster.

See page 19 'HOLD CALIBRATION' for how to calibrate.

For safety! When oil pressure goes below 10bar, the 'HOLD' function is deactivated.

Warning signals when using 'HOLD' function

The internal and external (if fitted) buzzer will give the following warning signals:			
	Warning signals	Cause	Effect
1.	Single short beep every 2.4 sec.	<ul style="list-style-type: none">Voltage below 9.3V/17.5V (12V/24V system).Temperature above 85°C/185°F.	None
2.	Two short beeps every 2.4 sec.	<ul style="list-style-type: none">Voltage below 8.9V/16.3V (12V/24V system).Temperature above 100°C/212°F.	None
3.	Red backlight in display and continuous short beeps.	<ul style="list-style-type: none">Voltage below 8.5V/15V (12V/24V system).Temperature above 110°C/230°F.	None
4.	Red backlight in display and continuous short beeps.	If one or more of the thrusters enters an alarm state - Voltage below 8.0V/12.0V (12V/24V system) or temperature above 120°C/248°F.	"HOLD" function are cancelled and both thrusters will stop. Temperature must drop below 110°C/230°F before the thruster can be operated again. Low Voltage alarm must be reset from panel.

Menu system

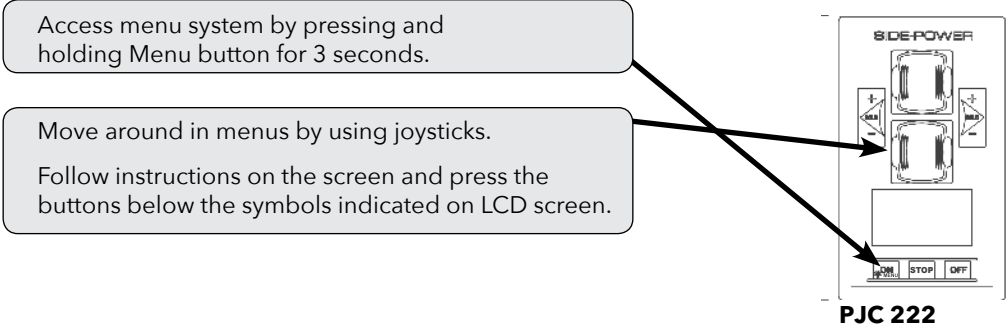

MAIN MENU ITEMS:
Move between main menu items with the (stern) joystick.

LANGUAGE	STABILIZER	SETUP	INFO	DEFAULT SETTINGS	PANEL SETUP
Language	Stabilizer (If installed)	Setup	Info	Default settings	Panel setup

BUTTON SYMBOLS
On the bottom line of the display, a symbol will be shown over the buttons below.
These symbols will show what function each corresponding button has in the selected menu entry.

Return to previous menu.	Select highlighted menu text / Save edited parameter.	Edit highlighted parameter.	Cancel editing without saving.	This symbol indicates that the (stern) joystick is used to move between menu items / parameters.

Menu system



LANGUAGE

- Choose language by moving joystick: English, Norwegian, German, French, Spanish, Italian and Danish.
- Press the button below to set the language to the highlighted menu entry. A star (*) on each side indicates the language set.



(Default in systems with stabilizers)

STABILIZER

(Shown only for yachts equipped with a Side-Power Stabilizer system)

Press the button below to edit the selected parameter. ON/OFF will start to blink, use joystick to alter value.
Press the button below to save edited parameter to device.

1. Stabilizer:

- Values: ON/OFF
- Switches the stabilizer ON or OFF.



2. AnySpeed:

- Values: ON/OFF
- Switches the zero speed/at anchor stabilization ON or OFF.

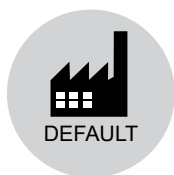

DEFAULT SETTINGS

- Reset all settings to factory default - follow instructions on screen
- Press the button below to confirm reset
- The following parameters/values will be set to the factory settings:

Language = English
Backlight Level = 5
Backlight Night Color = Green
Backlight Nightlevel = 1
Timer Auto-Off = 05 min
Hold Calibration = 70% Bow and Stern

All system devices will be erased from memory.
(Setup procedure must be followed to reconfigure the system)

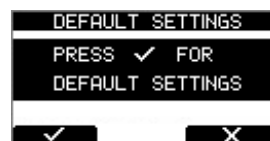

Setup procedure

The setup procedure requires knowledge of the serial number and location of all the S-link devices.

Write this down in the form on the last page to have the information at hand when doing a manual setup.

At the first startup of a new system, one of the two screens below will be shown:



1. SETUP DO NOT MATCH SYSTEM.

✓ FOR AUTO SETUP

New devices found. Not in conflict with other devices. Press button below the -symbol to auto setup.

Thrusters can not be operated to auto setup is completed.



2. RUN SETUP! DEVICES IN CONFLICT!

Detected devices in conflict. Two or more thrusters defined as same instance (bow/stern/bow STB/Stern STB). Run Setup procedure to correct.

Thrusters cannot be operated until seup is completed.



2.1

Press and hold the button marked "MENU" for 3 seconds to enter the menu system. Use the (stern) joystick to select "SETUP", Press button below the -symbol to enter the "SETUP"-menu.



2.2

Use the (stern) joystick to select "SYSTEM DEVICES", Press button below the -symbol to enter the "SYSTEM DEVICES"-menu.



2.3

Use the (stern) joystick to set the pin code one number at the time, press button below the -symbol to jump to next number and confirm. The pin code is "9 9 9 9".

NOTE: Re-entering the SYSTEM DEVICES menu within 15 minutes does not require entering PIN code



2.4

For about 2 seconds an hourglass will appear while scanning the S-link for devices. The devices found in the system is now displayed with their instance (thruster type and location) and serial number.

Go through all devices and make sure that they are set to the correct instance and function (refer to detailed instructions in the SETUP section of "Menu System"-chapter).

Press button below the -symbol to save setting and return to "Setup"- Menu.

Menu system - SETUP



(Default in systems without stabilizers)

SETUP

Move between menu items with the (stern) joystick.
Press the button below to select the highlighted menu entry.
Press the button below to return to the previous menu.

Setting done under SETUP will be sent to all other panels in the system.

SYSTEM DEVICES

View all devices connected to S-Link and manually change setup values.

A PIN code is required to enter the SYSTEM DEVICES menu.
Use the (stern) joystick to set the pin code one number at a time, press button below the -symbol to jump to next number and confirm.
The pin code is "9 9 9 9".

The number of devices found is shown in the upper right corner of the display.

Use (stern) joystick to move between the installed devices.

The list of devices found can fill more than one screen.
A scroll bar indicates the position of the selected item.

NOTE: Re-entering the SYSTEM DEVICES menu within 15 minutes does not require re-entering PIN code.



Hydraulic system - Setup

1. PHC 024 (Controller for hydraulic thrusters)

Most functions requires PHC 024 with firmware V.1.101 or newer!

Move between PHC-024 parameters with the (stern) joystick.
Press the button below to return to the previous menu.
Press the button below to edit the selected parameter.
Parameter value will start to blink, use joystick to alter value.
Press the button below to save edited parameter to device
Press the button below to cancel editing without saving.
(see section 4, page 16)

1.1 Bow/Stern Direction:
Values: Normal (default)/Inverted

Switches between Normal and Inverted running direction for the thruster.
Direction need to be inverted if incorrect prop rotation.

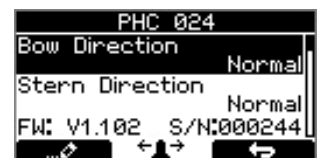

Menu system - SETUP



1.2 Pump Control (PTO Mounted Pump)

Values: Auto(default)/Always ON/Not Available

When «Pump Control» is set to «Auto», the system will automatically control load sharing between two PTO pumps by deactivating the second PTO pump when not needed (two PTO pumps/control valves required) to reduce heat generation in the system and save fuel/energy.

When any thruster is running, both PTO pumps will be active to ensure good performance. When an SPS stabilizer system is active, one PTO pump will be deactivated to save power. If stabilizers are active and the system pressure drops below 80bar, the system will activate the second PTO pump for 15 minutes to increase the flow capacity and maintain required pressure. After 15 minutes the second pump will be deactivated unless the pressure is still below 80 bar.

“Pump Control” is set to “Not Available” when “Thruster Stern” is set to “with Bypass Valve”. “Pump Control” will then not be able to edit.

NOTE: “Pump Control: Auto” must only be used on PHC 024 with firmware V.1.008 or higher!

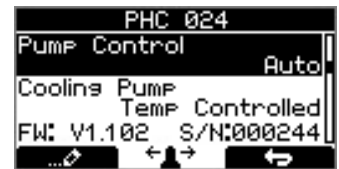

1.3 Cooling Pump

Values: Always Running/Temp Controlled(default)

When the option “Temp Controlled” is selected, the cooling pump will start when oil temperature exceeds 50°C/122°F and stop when the oil temperature goes below 40°C/104°F. On systems with two oil tanks, this setting will apply to both tanks.

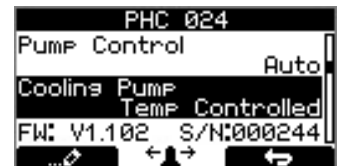

1.4 Cooling Signal Output

Values: Normal (default)/Inverted

Set to Normal when using a hydraulic cooling pump. Should be set to Inverted when using an electrical cooling pump with a 10 2380A-12/24V relay box

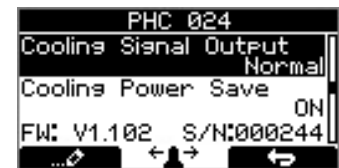

1.5 Cooling Power Save

Values: ON/OFF (default)

ON sets the Cooling Pump into power save mode, which means the Cooling Pump output is dropping to 0 volt when the oil pressure is below 10 bar for more than 10 seconds (Cooling Pump is turned OFF).

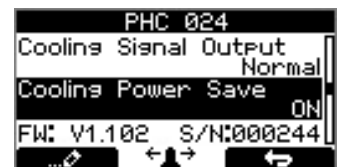

1.6 Tank Monitor

Values: ON (default)/OFF

ON is when you have a tank monitor, oil level and Oil temp sensor. OFF is when you do not have a tank monitor and the display will show 0°C and no alarm for high temperature or low level will not be transmitted on the S-link.



1.7 Thruster Bow (only available for PHC024 with FW V1.105 or higher)

Values: without Bypass Valve (default)/with Bypass Valve

All 513mm (20inch) tunnel and 610mm (24inch) tunnel thrusters, are supplied with hydraulic bypass/crossover valve and must be set to “with Bypass Valve”.

This bypass valve is normally open to protect the thruster during deceleration and will close while thruster is running.

By selecting “with Bypass Valve” you activate this signal and addition change ramp parameters to match this setup.

All other thrusters must be set to “without Bypass Valve”.



Note! With hydraulic retractable thrusters (SRHP) this must be set to ‘without Bypass Valve’

Menu system - SETUP



1.8 Thruster Stern (only available for PHC024 with FW V1.105 or higher)

Values: without Bypass Valve (default)/with Bypass Valve

All 513mm (20inch) tunnel and 610mm (24inch) tunnel thrusters, are supplied with hydraulic bypass/crossover valve and must be set to "with Bypass Valve".

This bypass valve is normally open to protect the thruster during deceleration and will close while thruster is running.

By selecting "with Bypass Valve" you activate this signal and addition change ramp parameters to match this setup.

All other thrusters must be set to "without Bypass Valve".

Note! With hydraulic retractable thrusters (SRHP) this must be set to 'without Bypass Valve'



1.9 Thruster Function (only available for PHC024 with FW V1.105 or higher)

Values: BOW/STERN (default)/ BOW/BOW / STERN/STERN

Thruster function is how the two thruster valves are set to work.

BOW/STERN: One thruster valve output runs on bow signal from control device, and the other thruster valve output runs on stern signal from control device.

BOW/BOW: Both thruster valve outputs runs on bow signal from control device.

STERN/STERN: Both thruster valve outputs runs on stern signal from control device.

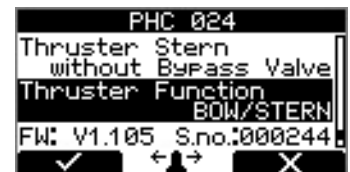

1.10 (1.7 if PHV024 FW version is lower than V1.105) Instance

Values: --(default)/PORT/STARBOARD

Setting the PHC024 tank controller instance. For a mono hull boat the instance should be "--". If you have a catamaran with two PHC024 controllers then the one in the port hull should be set as "PORT" and the one in the starboard hull as "STARBOARD". This way the two controllers are shown in the panel display as two different oil tanks to monitor.



2. PHC-3 (Controller for hydraulic thrusters)

Most functions requires PHC 024 with firmware V.1.101 or newer!

Press the button below  to return to the previous menu.

Press the button below  to edit the selected parameter.

Parameter value will start to blink, use joystick to alter value.

Press the button below  to save edited parameter to device

Press the button below  to cancel editing without saving.

PHC-3 have a lot of parameters that can be changed for different kind of setup.

All this parameters are available and can be changed on the PHC-3 controllers display.

2.1 Bow/Stern Direction:

Values: Normal (default)/Inverted

Switches between Normal and Inverted running direction for the thruster.

Direction need to be inverted if incorrect prop rotation.

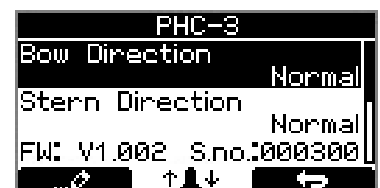

AC system - Setup



(Default in systems without stabilizers)

3. PDC 101

(SAC Controller) (This device is not able to edit. Pre-setup from factory.)
Press the button below to return to the previous menu.

PDC101 must be setup by authorized personnel.

Firmware version and serial number is Not Available (NA).

3.1 Location

Values: BOW/STERN/BOW-STB/STERN-STB
BOW or STERN in a conventional thruster system.
In a system with two bow or stern thrusters (i.e a catamaran), BOW and STERN is port thruster, BOW-STB and STERN-STB is starboard thruster.

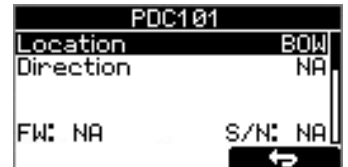

3.2 Direction

Values: NA (Not Available)

4. PDC 201

(SAC Controller)

Press the button below to return to the previous menu.

Press the button below to edit the selected parameter.

Parameter value will start to blink, use joystick to alter value.

Press the button below to save edited parameter to device

Press the button below to cancel editing without saving.

4.1 Location

Values: BOW/STERN/BOW-STB/STERN-STB
Set the location for selected device. Use BOW or STERN in a conventional thruster system. In a system with two bow or stern thrusters (i.e a catamaran), use BOW or STERN for port thruster, BOW-STB or STERN-STB for starboard thruster.



4.2. Direction

Values: Normal (default)/Inverted
Switches between Normal and Inverted running direction for the thruster.

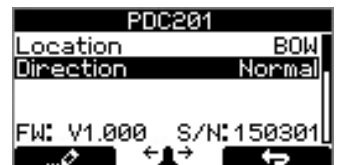

5. PDC 301

(SAC controller)

Press the button below to return to the previous menu.

Press the button below to edit the selected parameter.

Parameter value will start to blink, use joystick to alter value.

Press the button below to save edited parameter to device

Press the button below to cancel editing without saving.

5.1 Location

Values: BOW/STERN/BOW-STB/STERN-STB
Set the location for selected device. Use BOW or STERN in a conventional thruster system. In a system with two bow or stern thrusters (i.e a catamaran), use BOW or STERN for port thruster, BOW-STB or STERN-STB for starboard thruster.

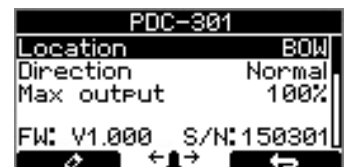

5.2 Direction

Values: Normal (default)/Inverted
Switches between Normal and Inverted running direction for the thruster.

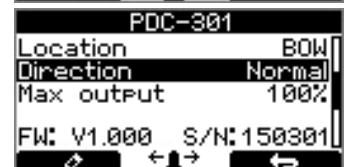

5.3 Max output

Values: 50% to 100%
Set the maximum output thrust of PHC-301 in percent.
PDC-301 will scale the input signal to this value.





(Default in systems without stabilizers)

DC system and device- Setup

6. MAIN SWITCH

Press the button below to return to the previous menu.
Press the button below to edit the selected parameter.
Parameter value will start to blink, use joystick to alter value.
Press the button below to save edited parameter to device
Press the button below to cancel editing without saving.

6.1 Location

Values: BOW/STERN/BOW-STB/STERN-STB

Set the location for selected device. Use BOW or STERN in a conventional thruster system. In a system with two bow or stern thrusters (i.e a catamaran), use BOW or STERN for port thruster, BOW-STB or STERN-STB for starboard thruster.

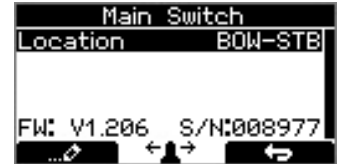

7. PPC - DC Speed Controller PPC520/ PPC820/ PPC840/ PPC800 SR150000 - Control unit for SRV80/SRV100/SRV130/SRV170/SRV210/SRH SR61242 - Control unit for SR80/SR100

Move between parameters with the (stern) joystick.

Press the button below to return to the previous menu.
Press the button below to edit the selected parameter.
Parameter value will start to blink, use joystick to alter value.
Press the button below to save edited parameter to device
Press the button below to cancel editing without saving.

7.1 Location

Values: BOW/STERN/BOW-STB/STERN-STB

Set the location for selected device. Use BOW or STERN in a conventional thruster system. In a system with two bow or stern thrusters (i.e a catamaran), use BOW or STERN for port thruster, BOW-STB or STERN-STB for starboard thruster.

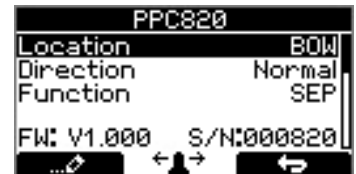

7.2 Direction

Values: Normal (default)/Inverted

Switches between Normal and Inverted running direction for the thruster

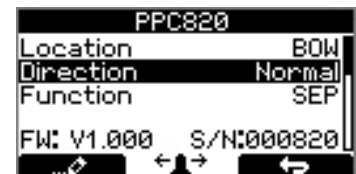

Menu system - SETUP



(Default in systems without stabilizers)

7.3 Function

Values: SR(V/L) ON/OFF, SRP, SRVP/SRLP, SEP, SRHP

Setup the control unit behaviour

- SR(V) ON/OFF: Retract thruster (SR6 1242 or SR150000) without speed controller (PPC520, PPC820, , PPC800, PHC-024).
Note! The joystick needs to be operated more than 50% for the thruster to run.
- SEP: Tunnel speed thruster, PPC without retract.
- SRP: Retract SR61242 with PPC, both devices needs to be set to SRP.
- SRVP/SRLP: Retract SR150000 with PPC, both devices needs to be set to SRVP/SRLP.
- SRHP/SRAC: PHC or SAC with retract
SRHP needs the PHC024 or PHC-3 hydraulic controller.
SRAC needs the PDC-301 SAC controller.

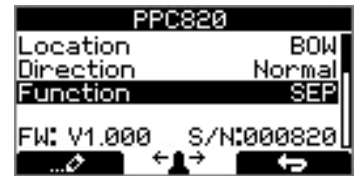

	PPC	SR150000	SR61242	PHC 024/ PHC-3	PDC-301
SR(V/L) ON/OFF		x	x		
SRP	x		x		
SRVP/SRLP	x	x			
SEP	x				
SRHP/SRAC		x		x	x

7.4 Max output

Values: 50%-100%

(this is only for PPC800 from V1.022 and PPC520/820/840 from V1.008)

Set the maximum output thrust of PPC in percent.
PPC will scale the input signal to this value.





(Default in systems without stabilizers)

8. RCRS-1 and RCRS-2

(S-Link Radio Remote Receiver)

Move between parameters with the (stern) joystick.

Press the button below  to return to the previous menu.

Press the button below  to edit the selected parameter.

Parameter value will start to blink, use joystick to alter value.

Press the button below  to save edited parameter to device

Press the button below  to cancel editing without saving.

8.1 BOW/STERN Thrust

Values: 0-100% (Default 75%)

Set the amount of thrust given by the remote control.

In a bow/stern configuration, try to balance the thrust so that the boat moves straight sideways when both thrusters are operated simultaneously with input from the remote only.

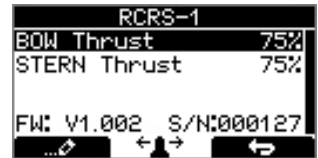

9. MSI8730

(S-Link Interface)

Move between parameters with the (stern) joystick.

Press the button below  to return to the previous menu.

Press the button below  to edit the selected parameter.

Parameter value will start to blink, use joystick to alter value.

Press the button below  to save edited parameter to device

Press the button below  to cancel editing without saving.

9.1 Location

Values: BOW/STERN/BOW-STB/STERN-STB

Set the location for selected device. Use BOW or STERN in a conventional thruster system. In a system with two bow or stern thrusters (i.e a catamaran), use BOW or STERN for port thruster, BOW-STB or STERN-STB for starboard thruster.



9.2 Thrust

Values: 0-100% (Default 70%)

Set the amount of thrust given by the remote control.

In a bow/stern configuration, try to balance the thrust so that the boat moves straight sideways when both thrusters are operated simultaneously with input from the remote only.



10. ESI-1 (External Single Interface)

GW-1 (Gateway)

Press the button below  to return to the previous menu.

This devices will only show firmware version and serial number at the button.



Menu system - SETUP



(Default in systems without stabilizers)

HOLD CALIBRATION

Calibrates the HOLD-function to get balanced thrust from the bow and stern thruster. If only one thruster or PJC221/PJC211 you will not get any balanced thrust, but you can adjust the maximum thrust from HOLD buttons. Hold-button represents 1/6 if the calibrated value.

Note! HOLD CALIBRATION is not available until SETUP is completed.

To start calibration, press the "+"-Hold button in the desired direction. For a first time calibration, the thrusters will start at 70%. A system previously calibrated will start with the last amount of thrust set.

Adjust power with the joystick.

Press the button below to save the calibration values.

Press the button below to cancel calibration without saving.

Note: Setup calibration in one direction sets values for both directions.

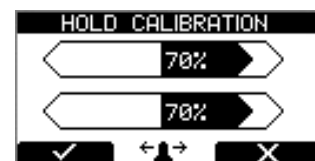

JOYSTICK CALIBRATION

(only for PJC2xx panels with HW V2)

This function is for calibrating the joysticks, and requires a pin code to enter.

This option is for service personnel only.



INFO

- Move between menu items with the (stern) joystick.
- Press the button below to select the highlighted menu entry.
- Press the button below to return to the previous menu.

THRUSTER INFO

Display info about the thrusters in the system.

The number of thrusters/controllers found is shown in the upper right corner of the display.

Use (stern) joystick to move between the installed devices.

Press the button below to select the highlighted menu entry.

Press the button below to return to the previous menu.

The list of devices found can fill more than one screen. A scroll bar indicates the position of the selected item.

The joystick(s) operates the thrusters as normal while info is displayed. This will be useful for troubleshooting, service and general system diagnostics.

List will only show devices present on the S-link.

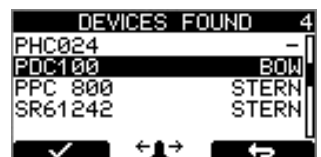

Menu system - INFO

PPC DC Speed Controller PPC520/ PPC820/ / PPC800

SR150000 Control unit for SRV80/SRV100/SRV130/SRV170/SRV210/SRH

SR61242 Control unit for SR80/SR100

- Motor Temp: Temperature measured at the electric motor brushes (Not implemented in SR61242)
- Contr. Temp: Temperature measured inside the controller (Not implemented in SR61242)
- Voltage: Motor Voltage measured at the controller
- Thrust: Thrust level from joystick/hold buttons
- °A/kW: Retract angle (SR150000) / Motor Current (PPC) / Effect reading (PPC). SR150000 retract angel is 0° when fully deployed, and about 90° when retracted. Put SR150000 in service mode and operate the controller manually in an out to read the two end position angels for service and installation.

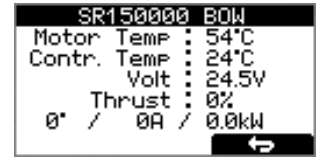

Press the button below  to return to the previous menu.

PHC-3 and PHC024 (Controller for hydraulic thrusters)

- Oil Pressure: Oil pressure measured at system oil tank
- Oil Temp: Temperature measured inside the oil tank
- Bow Thrust: Thrust level from joystick/hold buttons
- Stern Thrust: Thrust level from joystick/hold buttons
- FW: Version number, Firmware
- S/N: Serial number of the PHC

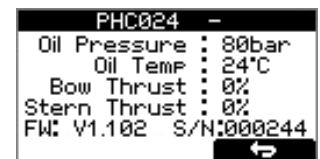

Press the button below  to return to the previous menu.

PDC101 and PDC 201 (Controller for AC electric thrusters)

- Motor Speed: RPM on motor output shaft
- Motor Power: Motor power consumption in % (PDC201 only)
- Motor Temp: Temperature measured in motor
- Thrust: Thrust level from joystick/hold buttons

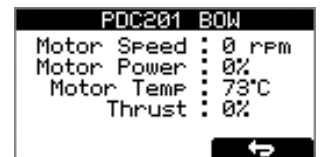

Press the button below  to return to the previous menu.

PDC-301 (SAC controller)

- Motor : speed (rpm), temperature (°C/°F), power (kW), AC current (A) & AC voltage (V).
- Thrust: Joystick thrust (%)



PANEL INFO

Display info about the control panel

- FW: Version number, Firmware
- HW: Version number, Hardware
- S/N: Serial number of the control panel
- Voltage: S-link system voltage measured at the panel



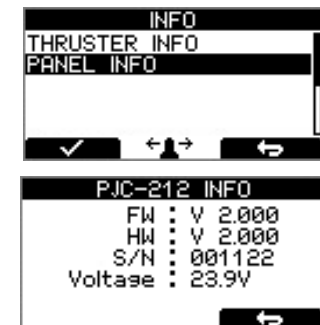

Press the button below  to return to the previous menu.

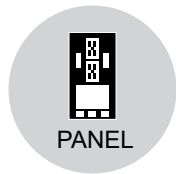

Menu system - PANEL SETUP



PANEL SETUP

- Move between parameters with the (stern) joystick.
- Press the button below  to return to the previous menu.
- Press the button below  to edit the selected parameter.
- Parameter value will start to blink, use joystick to alter value.
- Press the button below  to save the edited parameter.
- Press the button below  to cancel editing without saving.

BACKLIGHT LEVEL

Values: 1-5

Set level of panel backlight in daylight mode.

1 is lowest intensity, 5 is the highest.



BACKLIGHT NIGHT COLOR

Values: GREEN, BLUE, RED, WHITE

Select color of backlight in nightlight mode .



BACKLIGHT NIGHT LEVEL

Values: 1-3

Set level of panel backlight in daylight mode,

1 is lowest intensity, 3 is the highest.



TIMER AUTO-OFF

Values: OFF, 01-60 min

Set the time from last use to auto panel shutdown.

Set from 1-60 minutes in 5 minute steps (1 minute steps from 1 to 5 minutes) or OFF (panel will not turn off automatically).

Values when retract on the boat: 1-30 min.



UNIT TEMPERATURE

Values: CELSIUS (Default), FAHRENHEIT

Set the panel temperature displaying unit.



WHEN RETRACT IS OUT

Values: NO WARNING (Default), WARNING EVERY 10sec

Select 'WARNING EVERY 10sec' for external buzzer or lamp warning every 10 seconds when retract is out. This will activate the internal relay for 0.2 seconds every 10 seconds while the retract is out. See page 26 for buzzer connections.



RELAY OUTPUT

Values: ALERT LEVEL 1 , ALERT LEVEL 2 , ALERT LEVEL 3 (Default)

ALERT LEVEL 1: When using the HOLD Function the relay output warns if the motor temperature is getting high or if the voltage is getting low.

ALERT LEVEL 2: The relay output warns for all alarms and warnings in the S-link system only when any device is sending thrust. Even when the panel is turned OFF.

ALERT LEVEL 3: The relay output warns for all alarms and warnings in the S-link system. Even when the panel is turned OFF.



See 'Alarm descriptions' in "Ext. buzzer activation at Alert Level" column for specific alarm action.

PANEL FACING

Values: FORWARD (Default), AFT

FORWARD: Is when panel is facing forward

AFT: Is when panel is facing aft. Display view will rotate 180 degree and joysticks thruster function will also rotate 180 degree.



Alarm System

When there is an alarm or a fault, the panel will show this alarm situation by changing LCD display backlight to red color.

The panel will also change to show "Alarm Info"  on the bottom of the screen, indicating that by pressing the corresponding button below, you will get information about what the problem is (examples below). Entering "Alarm Info" menu will silence the alarm on all PJC221 and PJC222 panels.

Some alarms needs an reset to stop alerting.

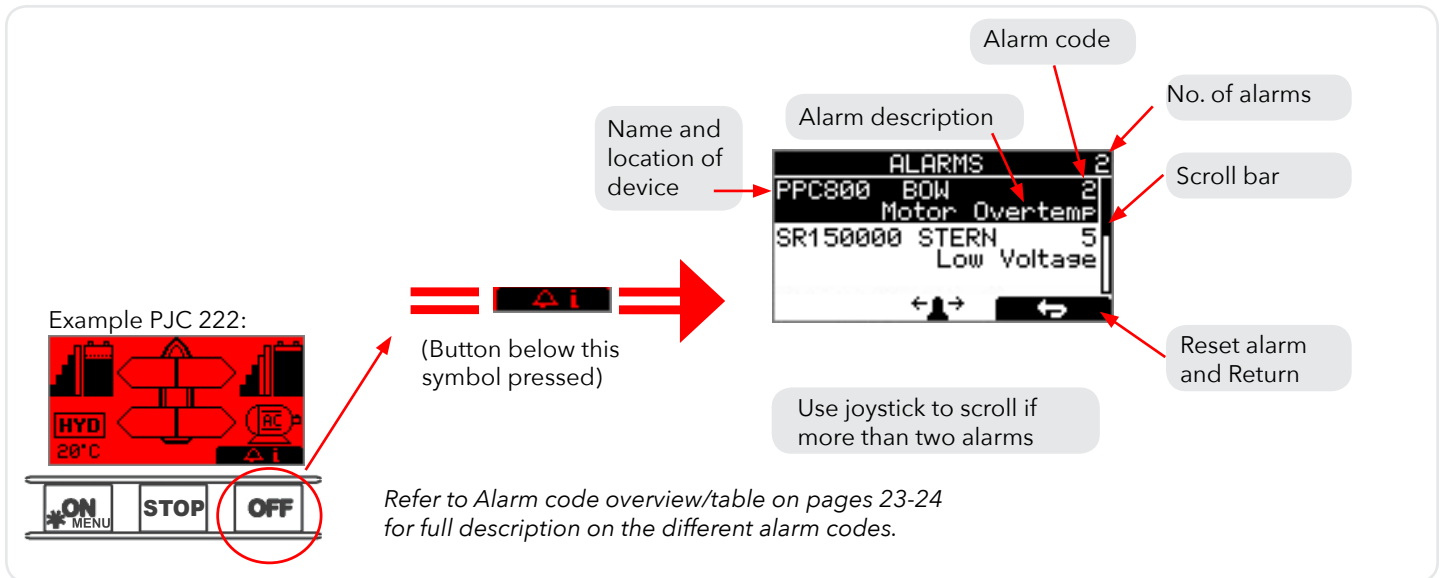

Example PJC 222:

(Button below this symbol pressed)

Refer to Alarm code overview/table on pages 23-24 for full description on the different alarm codes.

AUTO RESET

Some alarms are automatically reset when the fault is no longer present.

This means that this alarms don't need an manual reset action to be removed from the panel display and the audible alert to stop.

At 'Alarm Description' pages in the "Auto Reset" column you can see which alarms that are auto reset.

SPECIFIC ALARMS



STOP BUTTON

Pressing the STOP button on a hydraulic panel will activate the dump valve and all hydraulic consumers will be disabled. NB: FOR EMERGENCY USE ONLY

Panel will not run thrusters.

Pressing button below  will mute buzzer alarm at all panels and show the alarm info screen.



ALARM SHOWN ON INACTIVE PANELS!

This screen will be shown when any warning/alarm occurs.

Pressing button below  will mute buzzer alarm at all panels and show the alarm info screen.



WARNING! HIGH SPEED. STABILIZER NOT ACTIVE!

(Only for yachts equipped with a Side-Power Stabilizer system) Warning will show when yacht is driven at high speed with stabilizer system inactive. Please refer to the Stabilizer ECU manual for speed settings.

Pressing button below  will mute buzzer alarm at all panels and show the alarm info screen.

Alarm descriptions

"Err. No."	Errors shown in display	"Auto Reset"	"Ext. buzzer activation at Alert Level"	Description	Action
1	Motor Overcurrent		2 ⁽²⁾ , 3	Motor current too high.	"Thruster must be serviced by authorized personnel, reset or power OFF/ON PPC ⁽¹⁾ ."
2	Motor Overtemp	Yes	2 ⁽²⁾ , 3	"Motortemp has been over 120°C/248°F."	Motor cool down below 110°C /230°F.
3	Controller Overtemp		2 ⁽²⁾ , 3	"PPC ⁽¹⁾ temp has been over 80°C/176°F."	PPC ⁽¹⁾ cool down below 45°C/113°F.
4	Controller Overtemp		2 ⁽²⁾ , 3	"SR150000 temp has been over 80°C/176°F."	SR150000 cool down below 45°C /113°F.
5	Low Voltage		2 ⁽²⁾ , 3	Low motor voltage alarm when motor is running. 12V thruster below 8.00V 24V thruster below 12.00V	Recharge battery, reset or power OFF/ON device.
6	Thermoswitch	Yes	2 ⁽²⁾ , 3	Motor temp has been overheated.	Motor needs to be cooled down before operated again.
7	IPC Error		2 ⁽²⁾ , 3	Motor relay fault	"Turn off thruster battery main switch. Thruster must be serviced by authorized personel."
8	Critical Error		2 ⁽²⁾ , 3	PPC ⁽¹⁾ output fail	PPC ⁽¹⁾ must be sendt for service.
9	Low Motor Current		2 ⁽²⁾ , 3	Thruster uses no power	Check thruster connections or motor dead!
10	Motor Contactor		2 ⁽²⁾ , 3	No current on motor relay coil.	Check motor relay connections, short circuit or relay dead!
11	System Error		2 ⁽²⁾ , 3	Fatal error	Device must be serviced by authorized personel
12	No Communication		2 ⁽²⁾ , 3	No communication with device	Check S-Link cables and power connections.
13	Motor Temp Sensor		2 ⁽²⁾ , 3	Motor temperature sensor fail	Check for an open circiut on the temp sensor on the motor
14	Supply Voltage Fault		2 ⁽²⁾ , 3	No power	Check power connections
15	Fuse Blown		2 ⁽²⁾ , 3	Fuse blown	Replace fuse or check if main cable from battery and main cable to thruster has been switched
16	Manual Override	Yes	2 ⁽²⁾ , 3	Main switch manually overridden	Pull main switch
17	Motion OUT Fault		2 ⁽²⁾ , 3	Retract obstructed while deploying	Turn off all panels. Go for lower speed/ deeper water and retry.
18	Motion IN Fault		2 ⁽²⁾ , 3	Retract obstructed while retracting	Turn panel on and manually override main switch. Remove obstruction and try again.

1. PPC520, PPC820, PPC800, PPC840

2. Buzzer is only activated when any device is sending thrust on the S-link bus.

Alarm descriptions

"Err. No."	Errors shown in display	"Auto Reset"	"Ext. buzzer activation at Alert Level"	Description	Action
19	Actuator Fault		2 ⁽²⁾ , 3	Actuator not getting any power	"Check actuator connection or power to actuator. Reset alarm in alarm menu on PJC 211/212/221/222 or recycle power."
20	Pos.Sensor Fault		2 ⁽²⁾ , 3	Retract position sensor fail	Check position sensor cables and for sensor damage.
21	In Service Mode	Yes	2 ⁽²⁾ , 3	"Retract controller in service mode. Switch no. 4 is ON."	Check dipswitch setting on retract control box.
22	High Oil Temp	Yes	1, 2 ⁽²⁾ , 3	"Hydraulic oil temperature is higher than 75°C /167°F."	"Stop running and wait for temperature to drop. Check if cooling pump is running."
23	Low Oil Level		1, 2 ⁽²⁾ , 3	Hydraulic oil level is to low	Fill more hydraulic oil to the hydraulic tank.
24	Warning Return Filter	Yes	2 ⁽²⁾ , 3		Return filter element required replacing.
25	Warning Pressure Filter	Yes	2 ⁽²⁾ , 3		Pressure filter element required replacing.
26	Warning High Speed	Yes	1, 2 ⁽²⁾ , 3	"WARNING! High Speed. Stabilizer not active!"	
27	Stabilizer Fault	Yes	1, 2 ⁽²⁾ , 3	Any Stabilizer alarm.	Se stabilizer panel for more info.
28	AC Motor Overtemp	Yes	1, 2 ⁽²⁾ , 3	"Hydraulic AC motor power pack overtemp. Higher than 120°C/248°F."	Stop running and wait for temperature to drop.
29	AC Motor Sensor Fail		2 ⁽²⁾ , 3	"Hydraulic AC motor power pack temp sensor open circuit"	Check sensor cables.
30	Temperature Warning	Yes	2 ⁽²⁾ , 3 ⁽²⁾	High temperature warning.	Warns that the motor temperature is getting high.
31	Motor Overtemp	Yes	1, 2 ⁽²⁾ , 3	High temperature Alarm.	Se SAC manual for more details.
32	VFD Warning	Yes	2 ⁽²⁾ , 3	There is an warning from VFD.	Check VFD for more details.
33	VFD Not Ready	Yes	2 ⁽²⁾ , 3	The VFD is not ready.	Check VFD for more details.
34	VFD Fault		1, 2 ⁽²⁾ , 3	VFD has an Alarm.	Check VFD for more details.
35	Warning Low Voltage	Yes	2 ⁽²⁾ , 3 ⁽²⁾	Low motor voltage warning when motor is running. 12V thruster below 9.30V 24V thruster below 17.50V	
36	Not Calibrated	Yes	2 ⁽²⁾ , 3	Shaft Not Calibrated	See manual for how to calibrate.
37	VFD Com. Fault		2 ⁽²⁾ , 3	No Modbus communication with VFD	Check VFD Modbus cables and power.
38	Cooling Fan Fault		2 ⁽²⁾ , 3	Cooling fan stopped running or running too slow	Device must be sent for service

1. PPC520, PPC820 & PPC800, PPC840

2. Buzzer is only activated when any device is sending thrust on the S-link bus.

Technical specifications and measurements

Description	Minimum	Maximum	Units	Comment
Input voltage	9	31	Volt DC	Powered from S-Link
Current Voltage	20	120	mA	
External Alarm Buzzer Voltage		31	Volt DC	
External Alarm Buzzer Current		500	mA	Internally fused

Description	Value
Operating temperature	-10 to + 60 degrees C.
Storage temperature	-20 to + 70 degrees C.
IP rating front	IPx6
IP rating back	IPx4
Humidity	max 95% RH
EMC tested	Acc. to EN 60533
Weight	215 gr.

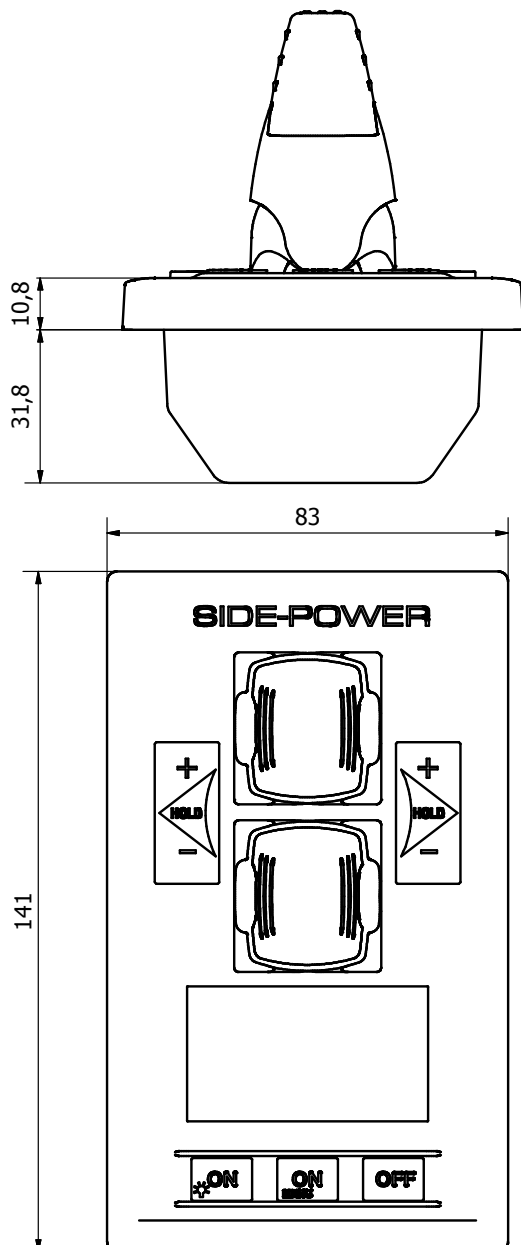

This illustration is for measurements use only. Use external template when mounting.

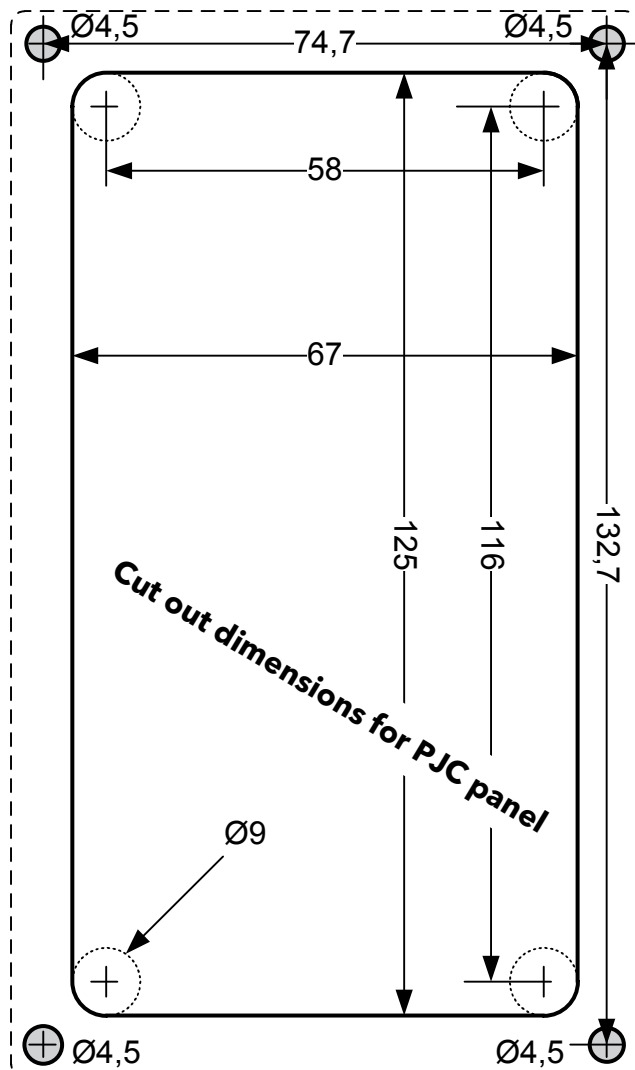

Connections

Connections for optional external buzzer/audible alarm.

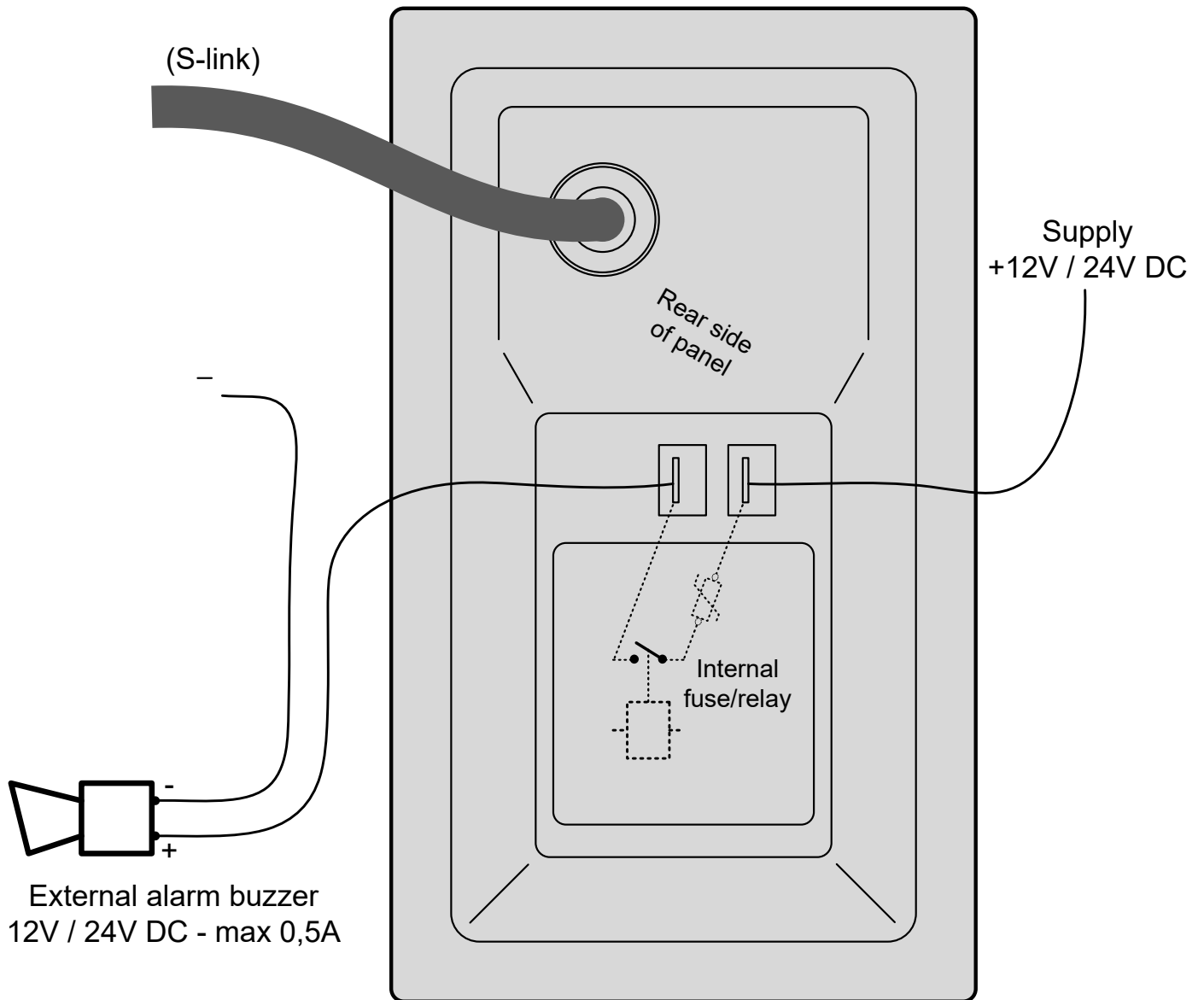

Note type, location and serial numbers

Fill in the type, location and serial numbers of the S-link devices installed.
Keeping this as a reference will make the setup procedure easier!

S-link device (ie Thruster, AMS, PPC etc)	Location (Bow, Bow-STB, Stern, Stern-STB)	Serial number

Worldwide sales and service



www.side-power.com



SLEIPNER MOTOR • AS P.O. Box 519 • N-1612 Fredrikstad • Norway

The information given in the document was correct at the time it was published. However, Sleipner Motor AS can not accept liability for any inaccuracies or omissions it may contain. Continuous product improvement may change the product specifications without notice. Therefore, Sleipner Motor AS can not accept liability for any possible differences between product and document.