

Installation Guide

For Hydraulic Thruster Models

SH100, SH160



SLEIPNER AS

P.O. Box 519

N-1612 Fredrikstad

Norway

www.sleipnergroun.com

DOCUMENT ID: 2746

REVISION: 28

DATE: 2021

LANGUAGE: EN

MI

Contents

Installation Manual

Responsibility of the Installer.....	3
Thruster Measurements	4
Thruster Specifications	5
Technical Specifications	5 - 6
Technical Requirements / Hydraulic Hose Connections To Motor.....	7
Positioning of the tunnel / thruster	8
Tunnel Length.....	9
Tunnel installation in sail boats.....	10
Water Deflection	11
Tunnel ends.....	12
Tunnel installation.....	13- 14
Stern tunnel installation.....	15
Gear Leg & Motor Bracket Installation.....	16
Propeller Installation.....	17
S-Link System Description	19
Control Panel Installation	20
Pre-delivery Checklist	21
Service and Support.....	22
Product Spare Parts and Additional Resources.....	22
Warranty Statement.....	22

Products

SH100/185T-U08 - SH100 Tunnel thruster, U08
SH100/185T-U10 - SH100 Tunnel thruster, U10
SH100/185T-U11 - SH100 Tunnel thruster, U11
SH160/215T-U08 - SH160 Tunnel thruster, U08
SH160/215T-U11 - SH160 Tunnel thruster, U11
SH160/215T-U14 - SH160 Tunnel thruster, U14
SH160/215T-U06 - SH160 Tunnel thruster, U06
SH160/215T-U10 - SH160 Tunnel thruster, U10
SH100/185T-U06 - SH100 Tunnel thruster, U06



Sleipner Motor AS
P.O. Box 519, Arne Svendsensgt. 6-8
N-1612 Fredrikstad, Norway

MC_0020

Failure to follow the considerations and precautions can cause serious injury, damage and will render all warranties given by Sleipner Motor as VOID.

MC_0411

Responsibility of the Installer

MC_0038

The installer must read this document to ensure necessary familiarity with the product before installation.

Instructions in this document cannot be guaranteed to comply with all international and national regulations. It is the responsibility of the installer to follow all applicable international and national regulations when installing Sleipner products.

The recommendations given in this document are guidelines ONLY, and Sleipner strongly recommends that advice is obtained from a person familiar with the particular vessel and applicable regulations.

This document contains general installation instructions intended to support experienced installers. If you are not skilled in this type of work, please contact professional installers for assistance.

If required by local regulation, electrical work must be done by a licensed professional.

Appropriate health and safety procedures must be followed during installation.

Faulty installation of Sleipner products will render all warranties given by Sleipner Motor AS.

General Installation Considerations and Precautions for Thrusters

MC_0425

- Do not install the thruster in a position where you need to cut a stiffener/ stringer/ support that may jeopardise the hull integrity without checking with the boat builder this can be done safely.
- We advise painting the gear house and propellers with anti-fouling. **(NB: Do not paint the anodes, sealing, rubber fittings or propeller shafts)**
- Do not finish the inside of the tunnel with a layer of gel-coat/ topcoat or similar. There is only room for a thin coat of primer and two layers of anti-fouling between the tunnel and the props.
- Never run the thruster out of water.
- The electro/ hydraulic motor must be handled with care. Do not place down the motor on the drive shaft.

General Installation Considerations and Precautions for Hydraulic Thrusters

MC_0009

If an original Side-Power hydraulic system is NOT installed, please ensure the following:

- Install an oil filter to keep the oil clean.
- Fit an oil cooler or use an oil tank to ensure the maximum oil temperature is 43 - 50 degrees Celsius.
- Hydraulic thrusters are supplied with hydraulic motors only.
- The installed hydraulic system is the responsibility of the fitter/ installer and must be within the limitations outlined in this manual to ensure no damage is caused to the thruster.
- The hydraulic valve must have flow and pressure limits that are either set within or can be adjusted to the limits of the thrusters capability.
- We strongly advise that a shock valve is fitted and set to 10% - 15% above the chosen maximum pressure set in the valve. This will prevent the system from being damaged if the propellers are blocked for any reason.
- It is required that a device is installed to ensure that the drive direction cannot be suddenly changed, as this can severely damage the gear house. **(NB: By adding an electronic time-lapse/delay safety on the electric control system or by using a valve that has this type of protection built in will prevent this issue. *The required time delay is 1 second.)**

Considerations and Precautions for S-Link Systems

MC_0105

When installing an S-Link™ system DO NOT connect any other control equipment directly to the S-Link™ bus except original Sleipner S-Link™ products. In case of connecting third-party equipment, it must always be connected through a Sleipner-supplied interface product. Any attempt to directly control or connect into the S-Link™ control system without a designated and approved interface will render all warranties and responsibilities of all of the connected Sleipner products.

If you are interfacing the S-Link™ bus by agreement with Sleipner through a designated Sleipner supplied interface, you are still required to install at least one original Sleipner control panel to enable efficient troubleshooting if necessary.

Measurement code	Measurement description	*100		*160		*240	
		mm	inch	mm	inch	mm	inch
ID	Internal tunnel diameter	185	7.28	215	8.46	250	9.84
H	Motor Height	215	8.46	195	7.68	235	9.25
W	Width	200	7.87	200	7.87	200	7.87
L	Length	215	8.46	195	7.68	235	9.25
WD	Water Depth	200	7.87	215	8.46	250	9.84
TL	Minimum tunnel length	170	6.69	280	11.02	300	11.81
TL (recommended)	Recommended tunnel length	340	13.39	560	22.05	600	23.62
T (min)	Minimum tunnel wall thickness	6	0.24	6	0.24	7	0.28
T (max)	Maximum tunnel wall thickness						

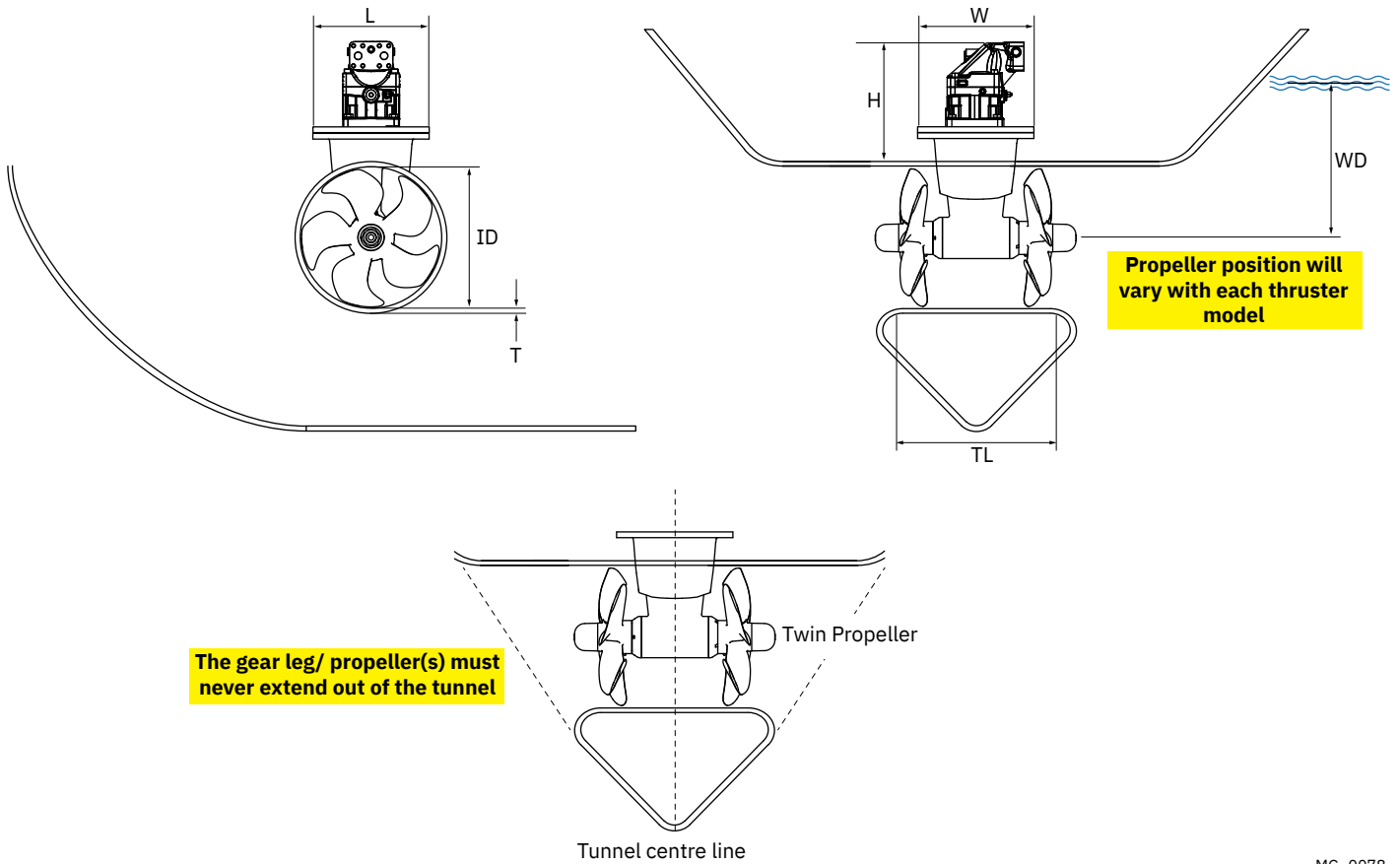

Thruster Specifications

MC_0144

Description	* 100	* 160	* 240
Light duty thrust up to (kg * lbs)	100kg * 220lbs	160kg * 352lbs	240kg * 529lbs
Heavy duty thrust up to (kg * lbs)	80kg * 176lbs	140kg * 308lbs	220kg * 440lbs
Typical Boat Size (m * ft)	9m - 16m * 30ft - 34ft	11m - 19m * 35ft - 62ft	13m - 23m * 42ft - 75ft
Propulsion System	Twin	Twin	Twin Counter Rotating
Power (kw * Hp)	6.9kw * 9.3hp	10kw * 13.4hp	14.9kw * 20hp
Weight (kg * lbs)	7.8 kg * 17.19 lbs	11.4 kg * 25.13 lbs	13.5 kg * 29.76 lbs
Lubrication	Sealed	Sealed	Sealed

Technical Specifications

MC_0056

- Motor:** Hydraulic type (specifications above).
- Gear house:** Seawater resistant bronze. Ball-bearing at propeller shaft and a combination of ball bearing and slide bearing at drive shaft.
- Gears:** Hardened precision gears
- Lubrication:** Oil bath from tank (gear oil EP 90)
- Bearings:** Angular contact ball bearing at propeller shaft and combination of ball bearing and needle bearing at drive shaft.
- Motor bracket:** Seawater resistant aluminium, galvanically insulated from the motor.
- Tunnel:** Cross spun with rowing G.R.P tunnel
Steel & aluminium tunnels available at request.
- Propeller:** SH 100/ SH 160/ SH 240/ SH 320/ SH 360: 5-blade skewback "Q-prop" propeller, fibreglass reinforced composite.
SH 420/ SH 550 Symmetrical 4 blade kaplan propeller, fibreglass reinforced composite.
- Safety:** Flexible coupling between hydraulic-motor and drive shaft protects gear system if propeller jams.

Technical Specifications

Thruster model	Motor type		60 %		80 %		100 %	
			Flow	Pressure	Flow	Pressure	Flow	Pressure
SH 100	U6	L/min -Bar	18.8	103	21.7	137	24.2	172
		USG-PSI	5.0	1494	5.7	1987	6.4	2494
	U8	L/min -Bar	25.5	77	29.9	103	32.3	129
		USG-PSI	6.6	1117	7.6	1494	8.5	1871
	U10	L/min -Bar	31.3	62	36.1	82	40.4	103
		USG-PSI	8.3	899	9.5	1189	10.7	1494
SH 160	U6	L/min -Bar	18.6	150	21.5	200	24	250
		USG-PSI	4.9	2175	5.7	2900	6.3	3625
	U8	L/min -Bar	24.8	112	28.6	150	32.0	187
		USG-PSI	6.6	1624	7.6	2175	8.5	2712
	U10	L/min -Bar	31.0	82	35.8	120	40.0	150
		USG-PSI	8.2	1305	9.5	1740	10.6	2172
	U11	L/min - Bar	34.1	82	39.3	109	44.0	136
		USG-PSI	9.0	1189	10.4	1581	11.6	1972
	U14	L/min -Bar	43.1	64	49.7	86	55.6	107
		USG-PSI	11.4	928	13.1	1247	14.7	1552
SH 240	U8	L/min -Bar	19.1	217	21.4	275	21.4	275 ¹⁾
		USG-PSI	5.05	3147	5.65	3988	5.65	3988 ¹⁾
	U10	L/min -Bar	23.8	174	27.5	232	30	275 ²⁾
		USG-PSI	6.29	2523	7.23	3364	7.93	3988 ²⁾
	U11	L/min -Bar	26.2	158	30.2	211	33.8	264
		USG-PSI	6.9	2291	8.0	3060	8.9	3828
	U14	L/min -Bar	33.1	124	38.2	166	42.7	207
		USG-PSI	8.7	1798	10.1	2407	11.3	3002
	U16	L/min -Bar	38.1	109	44.0	145	49.2	181
		USG-PSI	10.1	1581	11.6	2103	13.0	2625
	U19	L/min -Bar	45.1	92	52.1	122	58.3	153
		USG-PSI	11.9	1334	13.8	1769	15.4	2219
SH320	U11	L/min -Bar	23.8	249	24.9	274	24.9	274 ³⁾
		USG-PSI	6.29	3611	6.58	3973	6.58	3973 ³⁾
	U14	L/min -Bar	30.1	196	34.7	261	35.6	274 ⁴⁾
		USG-PSI	7.95	2842	9.17	3785	9.41	3973 ⁴⁾
	U16	L/min -Bar	34.6	171	39.9	229	43.7	274 ⁵⁾
		USG-PSI	9.14	2480	10.54	3321	11.55	3973 ⁵⁾
	BA16	L/min -Bar	33.8	172	39.0	230	43.6	287
		USG-PSI	8.93	2494	10.30	3335	11.52	4162
	U19	L/min -Bar	41.0	144	47.3	193	52.9	241
		USG-PSI	10.83	2088	12.50	2799	13.98	3495
	BA19	L/min -Bar	40.1	145	46.3	194	51.8	242
		USG-PSI	10.59	2103	11.44	2813	13.69	3509
U23	L/min -Bar	49.4	121	57	162	63.8	202	
	USG-PSI	13.05	1755	15.06	2349	16.86	2929	
SH360	U19	L/min -Bar	46.5	177	53.7	236	55	248 ⁵⁾
		USG-PSI	12.3	2567	14.17	3423	14.53	3597 ⁵⁾
	BA19	L/min -Bar	45.3	176	52.3	234	58.5	293
		USG-PSI	11.97	2553	13.82	3394	15.45	4250
	U23	L/min -Bar	56.3	146	65.1	195	310	310 ⁷⁾
		USG-PSI	14.88	2118	17.2	2828	81.89	4496 ⁷⁾
	BA23	L/min -Bar	54.5	146	62.3	196	70.3	245
		USG-PSI	14.4	2118	16.46	2843	18.57	3553
SH400	U19	L/min -Bar	43.5	195	50.2	260	54.2	302 ⁸⁾
		USG-PSI	11.49	2828	13.26	3771	14.32	4380 ⁸⁾
	BA23	L/min -Bar	52.3	163	60.4	218	67.5	272
		USG-PSI	13.82	2364	15.96	3162	17.83	3945
SH 420	U26	L/min -Bar	44.7	188	51.6	251	56.2	298 ⁹⁾
		USG-PSI	11.81	2726	13.63	3640	14.85	4321 ⁹⁾
	U29	L/min -Bar	49.8	169	57.6	225	64.3	281
		USG-PSI	13.16	2450	15.22	3263	16.99	4075
	BA32	L/min -Bar	48.4	151	55.8	202	62.4	252
		USG-PSI	12.78	2190	14.74	2929	16.49	3654
	U33	L/min -Bar	56.1	148	64.7	198	72.4	247
		USG-PSI	14.82	2146	17.09	2871	19.13	3582
	U37	L/min -Bar	62.1	132	71.8	176	80.2	220
		USG-PSI	16.41	1914	18.97	2552	21.19	3190
	BA40	L/min -Bar	61	121	70.4	161	78.7	202
		USG-PSI	16.12	1755	18.6	2335	20.79	2929
SH550	BA40	L/min -Bar	69.8	158	80.5	211	90	264
		USG-PSI	18.44	2291	21.27	3060	23.78	3828
	P42	L/min -Bar	84.2	152	97.2	203	108.7	254
		USG-PSI	22.25	2204	25.68	2944	28.72	3683
	G45	L/min -Bar	89.5	142	103.4	190	115.6	237
		USG-PSI	23.65	2059	27.32	2755	30.54	3437
	BA45	L/min -Bar	77.8	139	89.9	185	100.5	232
		USG-PSI	20.56	2016	23.75	2683	26.55	3364
	U50	L/min -Bar	95	128	109.7	171	122.7	213
		USG-PSI	25.10	1856	28.98	2480	32.42	3089
	P52	L/min -Bar	105.1	124	121.4	166	135.7	207
		USG-PSI	27.77	1798	27.77	2407	35.85	3002
	BA60	L/min -Bar	104.6	106	120.8	141	135.1	176
		USG-PSI	27.64	1537	31.92	2045	35.69	2552

- 1) Max. thrust: 182kg
- 2) Max. thrust: 228kg
- 3) Max. thrust: 211kg
- 4) Max. thrust: 269kg
- 5) Max. thrust: 302kg
- 6) Max. thrust: 307kg
- 7) Max. thrust: 310kg
- 8) Max. thrust: 370kg
- 9) Max. thrust: 399kg

U, P & G-motor:

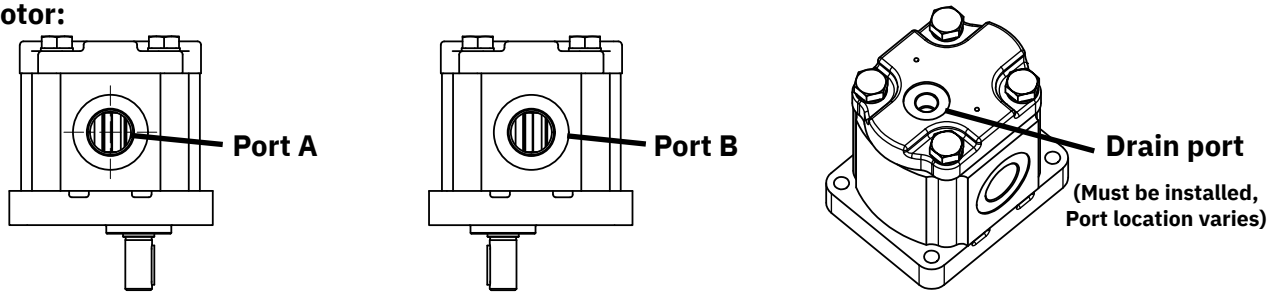

BA-motor:

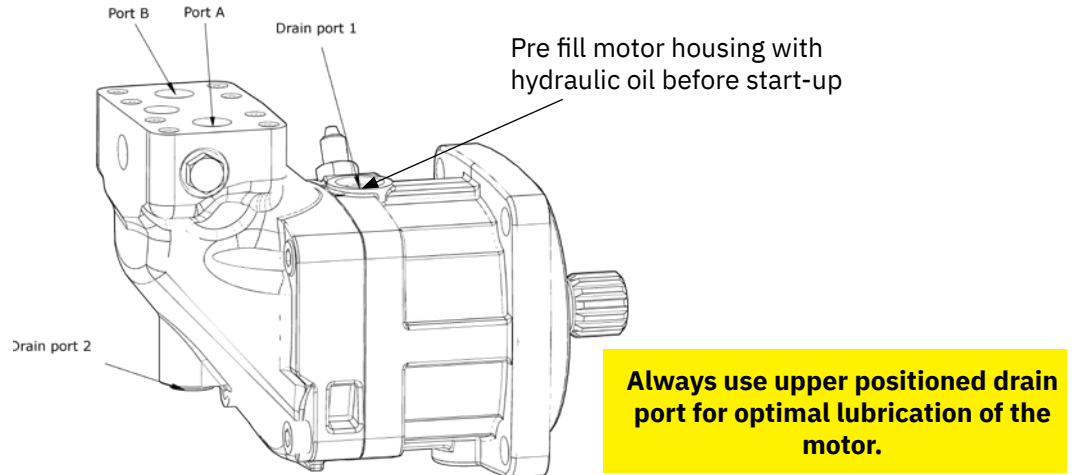

Motor type	Port A/B**	Port flange threads	Drain port
U6	1/2" BSP	—	1/4" BSP
U8	1/2" BSP	—	1/4" BSP
U10	3/4" BSP	—	1/4" BSP
U11	3/4" BSP	—	1/4" BSP
U14	3/4" BSP	—	1/4" BSP
U16	3/4" BSP	—	1/4" BSP
U19	3/4" BSP	—	1/4" BSP
U26	3/4" BSP	—	1/4" BSP*
U29	3/4" BSP	—	1/4" BSP*
U33	3/4" BSP	—	1/4" BSP*
U37	3/4" BSP	—	1/4" BSP*
U37	3/4" BSP	—	1/4" BSP*
U50	1" BSP	—	1/4" BSP*
P42	1" 3000 PSI SAE J518/ ISO 6162 Code 61	3/8-16 UNC-2B, 22 deep	1/4" BSP*
P52	1 1/2" 3000 PSI SAE J518/ ISO 6162 Code 61	M12 x 1,75, 19 deep	1/4" BSP*
G45	1 1/4" BSP	—	1/4" BSP*
BA16	1.1/16" - 12UN-2B	—	9/16" UNF-18
BA19	3/4" BSP	—	3/8" BSP*
BA32/ BA23	1/2" 6000 PSI SAE J518/ ISO 6162 Code 62	5/16-18 UNC-2B, 18 deep	3/4" UNF-16
BA40	3/4" 6000 PSI SAE J518/ ISO 6162 Code 62	3/8-16 UNC-2B, 20 deep	3/4" UNF-16
BA45	3/4" 6000 PSI SAE J518/ ISO 6162 Code 62	3/8-16 UNC-2B, 21 deep	3/4" UNF-16
BA60	3/4" 6000 PSI SAE J518/ ISO 6162 Code 62	3/8-16 UNC-2B, 22 deep	7/8" UNF-16

* Drain port connector must not extend internally beyond 10,5mm from end face.

** Use only parallel threaded adaptors, preferably with soft seal. Do not use plumbing tape, hemp, tread sealant or similar products.

Aim to install the thruster as far forward as possible (1)

Due to the leverage effect around the boats' pivot point. The distance difference from the boat pivots' point to the thruster will determine the amount of real rotation power for the boat.

Aim to install the thruster as deep as possible under the waterline (2)

Deeper installations prevent air from being sucked into the tunnel from the surface, resulting in reduced thrust performance and increase noise levels during operation. Deeper installations increase water pressure for maximum efficiency from the thruster.

The centre of the tunnel should be a minimum of 1 x the tunnel diameter below the waterline. The installer must make evaluations based on thruster performance, boat type and operating conditions. As a general recommendation, the position of the tunnel should not be a minimum of 1/4 of the diameter of the tunnel from the boat keel. **(NB: This can be overlooked depending on the installation methods defined in this manual.)**

1

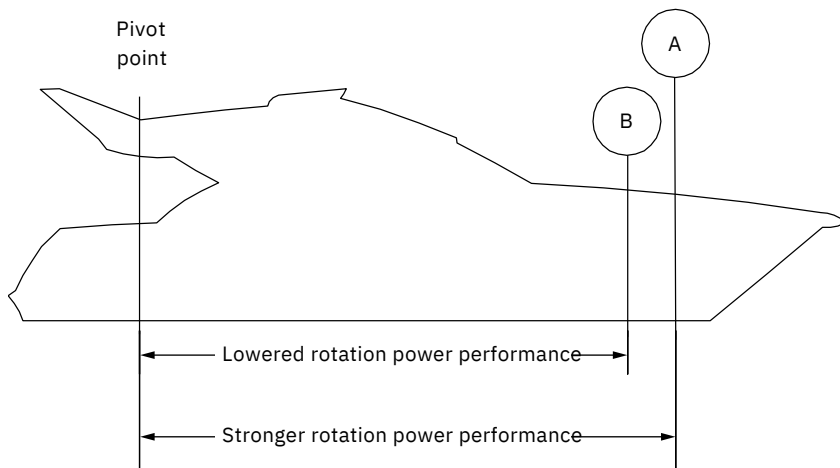

2

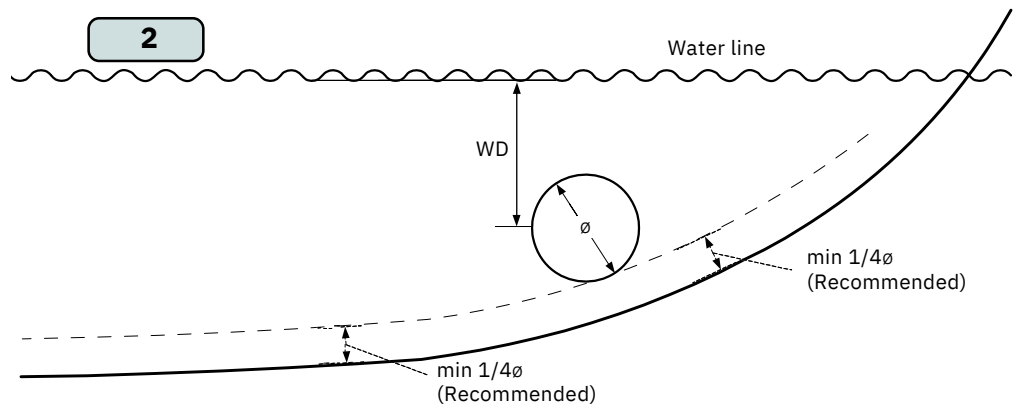

MG_0001

Optimal tunnel length

Achieving the correct tunnel length depends on many factors from the hull type, operation and environmental conditions.

Tunnels should avoid being longer than 4 x the tunnel diameter as this will reduce thruster performance. **(NB: Installing long length tunnels can flex/bend over time and may require additional support. Consult with a naval architect.)**

1. Do not allow the variable length of the tunnel walls to vary in length excessively.
EG. The top tunnel wall is x 4 longer than the bottom wall.
2. If the tunnel is too long, the friction inside will reduce the water speed and thereby the thrust.
3. If the tunnel is too short (typically only in the bottom section of the tunnel) cavitation problems can occur as water flow will not be able to "straighten" itself before reaching the propeller. This cavitation will reduce performance and increase noise during operation.

Thruster within the tunnel

It is important the propellers and the lower unit/ gear leg must be entirely inside the thruster tunnel. Propellers that protrude from the tunnel will not perform as intended.

4. Standard Use

Tunnel length must be long enough to ensure the propellers are not extruding the tunnel.

5. Flat Bottom Hull

Tunnel lengths must be longer than the standard measurement outlined within the manual to ensure a circular vacuum is not created between the thruster and the bottom of the boat.

6. High-Speed Boats

Tunnel lengths must be increased to protect the propeller from damage when crashing against the water surface during high-speed cruising. **(NB: This can include the length of a spoiler)**

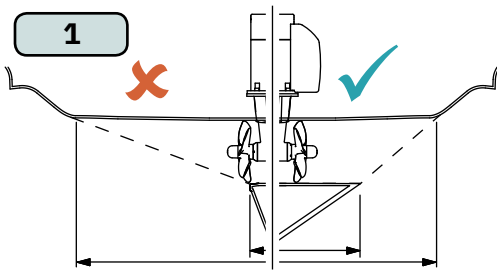

Do not allow the variable length of the tunnel walls to vary in length excessively.
EG. the top tunnel wall is x 4 longer than the bottom wall.

3

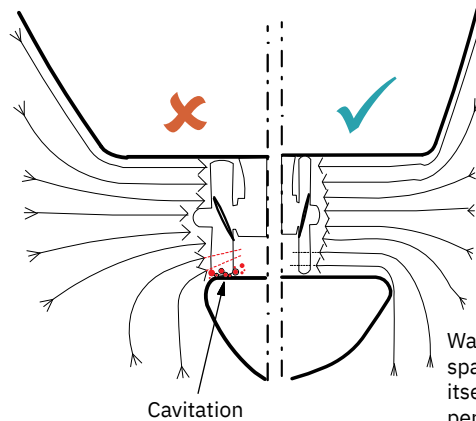

Water flow must have space to "straighten" itself for best performance.

2

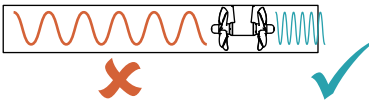

4 STANDARD USE

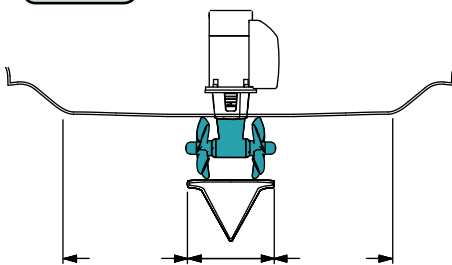

The gear leg/ propeller(s) must never extend out of the tunnel

5 FLAT BOTTOM HULL

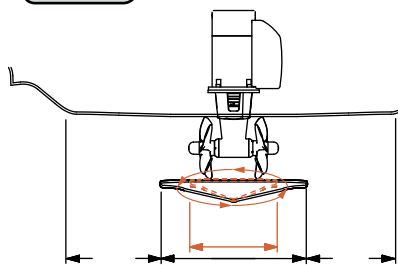

Increase tunnel length to prevent a circular water vacuum cavity between the propeller and the hull of the boat.

6 HIGH-SPEED OPERATION

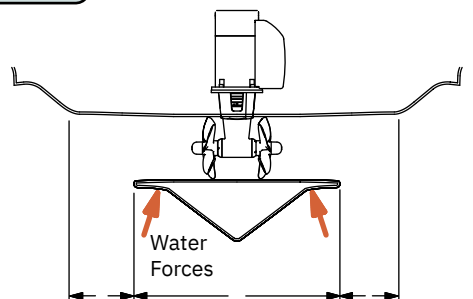

Increase tunnel length to protect the propeller from water forces when high-speed cruising.

MG_0048

Some sail boats have a flat bottom and shallow draft in the bow section. This can make installing the thruster as far forward from the boats main pivot point difficult. **(Fig. 1).**

However, it is possible to install a tunnel thruster in most sail boats, even when the hull does not directly support the fitting of a tunnel.

Instead fit the tunnel halfway into the underneath section of the existing hull. Strengthen it with a deflector/ spoiler directing the water flow around the tunnel. This will allow installation of the thruster in the proper position on the boat, maintaining the reliability and space advantages of the tunnel thruster.

This installation is being used by some of the world's largest sail boat builders and has proven to give little to no speed loss during normal cruising. This can also be an installation method for flat bottomed barges to avoid extremely long tunnels and large oval tunnel openings in the hull.

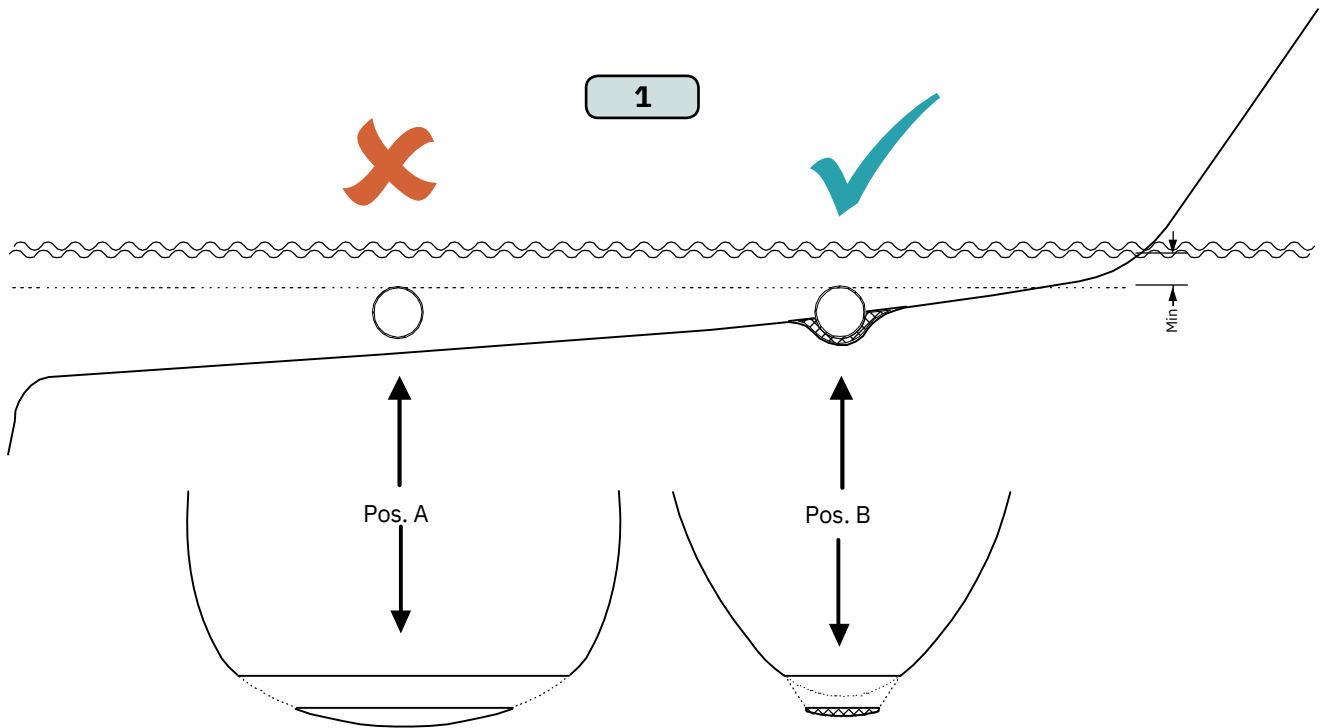

MG_0004

1. A possible problem in sail boats or fast powerboats is that a non-rounded surface can generate drag from the back face of the tunnel, as it creates a "flat" area facing the flow of water.

This problem can be solved in two different ways, depending on what is possible or easier to perform.

2. The best solution which generally reduces the most drag is to make a recess in the hull at the back of the tunnel. As the back face is removed water can flow freely past the tunnel entry. The depth and shape of this recess will depend on the boat and the angle facing up/ down aft of the tunnel insert. Normally it is angled slightly down because of the water flow on this area.
3. Making a deflector/ spoiler in front and underneath the tunnel can also reduce damage to the thruster and drag. The deflector/ spoiler will push the water flow out from the hull so water can pass by the back face of the tunnel. The shape and size of this deflector/ spoiler will depend on the hull shape. The easiest way of making the deflector/ spoiler is to retain a part of the lower forward area of the tunnel while installing the tube. Use this area as support to mould a soft curve/spoiler shape from the hull.
4. The thruster propeller can spin (passively) producing noise while sailing or cruising as water is forced through the tunnel. Water-flow directed through the tunnel at high speeds, during turning or as the boat bumps waves while underway can also damage the thruster.

(NB: As a rule, you should not see the back face of the tunnel when standing directly in front of the boat looking aft.)

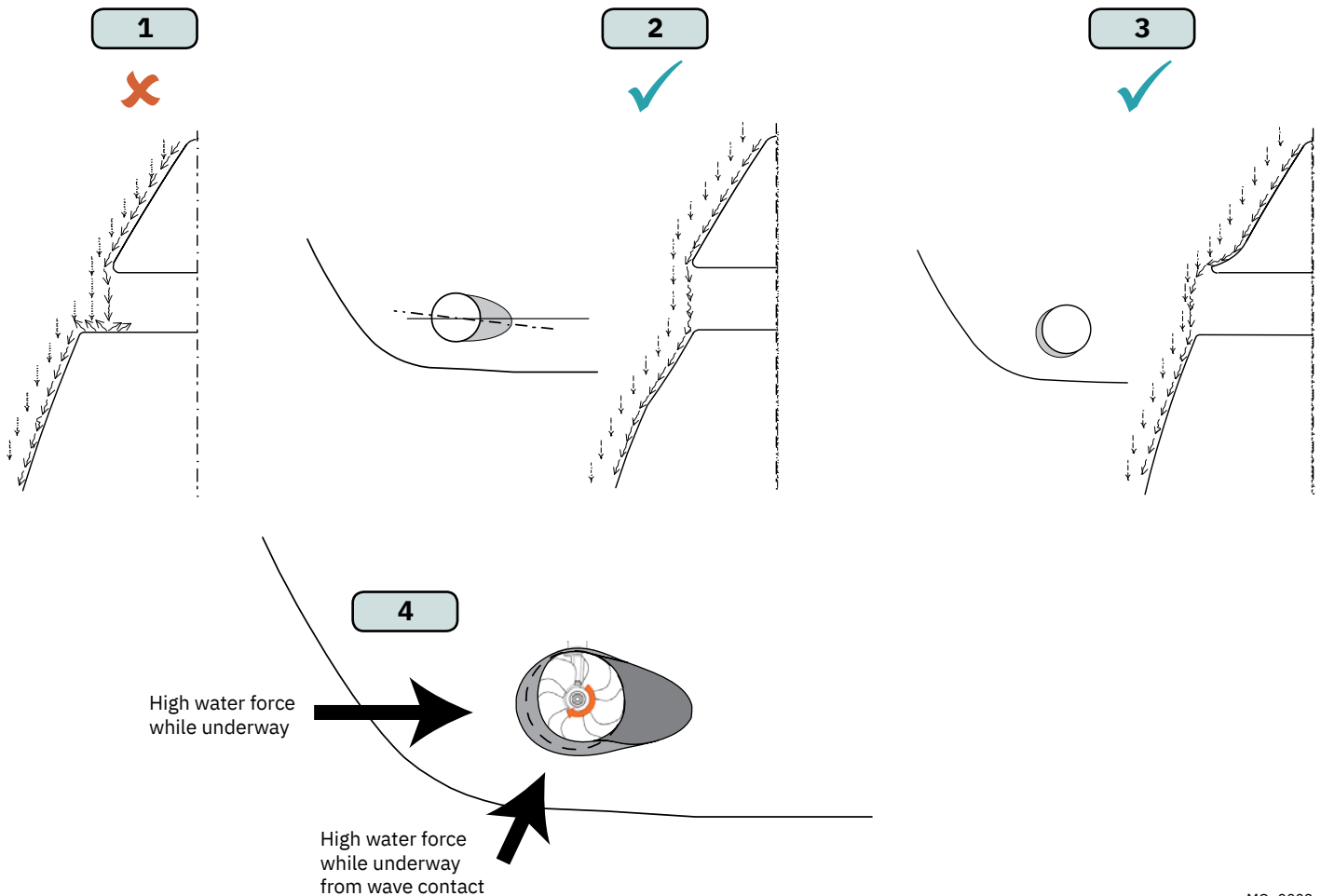

Rounded tunnel ends will maximise thrust and minimise noise and cavitation.

For best performance round the tunnel connection to the hull-side as much as possible. The minimum rounding has a radius of 10% of the diameter of the tunnel.

Significant advantages of a rounded tunnel over a sharp tunnel to hull connections are:

1. A rounded tunnel end will prevent the creation of turbulence/ cavitation created from a sharp tunnel end when water passes by the tunnel.
 - The turbulence/ cavitation will block the outer area of the tunnel and thereby reduces the effective tunnel diameter and thrust.
 - Turbulence/ cavitation on the propeller will lessen the thrusters performance and create excess noise.
2. For steel/ aluminium hulls angled tunnel ends also offer similar performance as a rounded connection.
3. A rounded tunnel end makes the thruster draw water from along the hull-side, creating a vacuum that will suck the boat sideways and thereby give additional thrust.
 - With a sharp tunnel end, the thruster will be unable to take water from along the hull-side, and you will not gain the desired vacuum and additional thrust. This "free" extra thrust in optimal installations be 30 - 40% of the total thrust.

(NB: A Side-power thruster propeller does not produce cavitation at working speed. Therefore, any cavitation and cavitation noise in the tunnel will be caused during improper tunnel installation.)

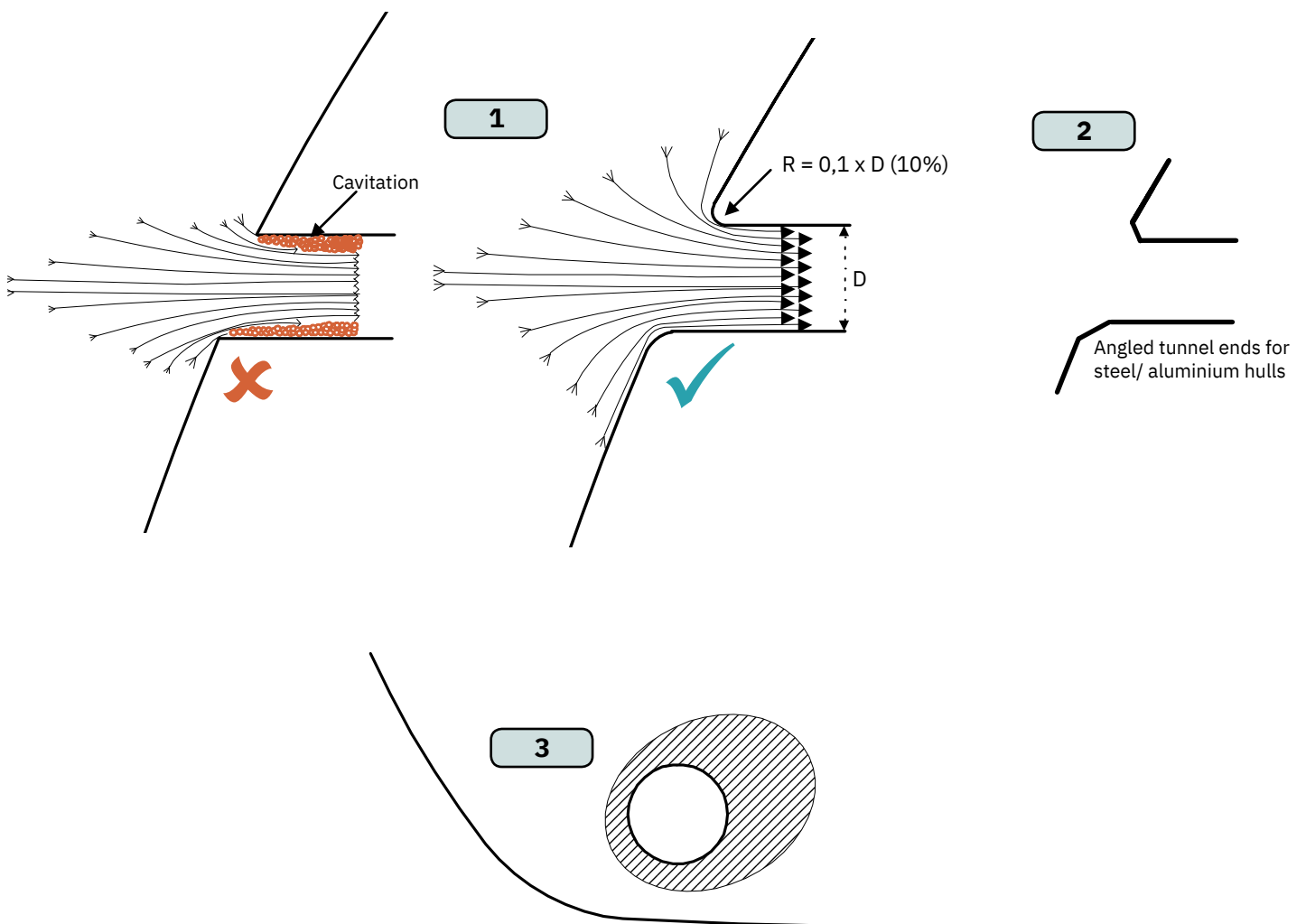

IMPORTANT

We recommend that a professional does the fibreglass, steel or aluminium fitting of the tunnel. These instructions are only general instructions and do not explain in any way the details of fibreglass work. Problems caused by faulty installation of the tunnel, are the installers full responsibility.

1. Find the position in the boat considering the information earlier in this manual and the applicable measurements for the thruster model you are installing. Mark the centre of the tunnel on both sides of the hull. Drill a hole horizontally at these marks.
2. Mark the circle for the tunnel opening (outside diameter of the tunnel) and cut the hole.
3. Grind off the gel coat to the “real fibreglass” area 12cm around the hole on both inside and outside the hull to cast the tunnel to the hull (**Fig. 3**).
4. Insert the tunnel and mark its shape to fit the hull. (**NB: if you are installing with a deflector/ spoiler, leave a part of the tunnel in the front and underside of the tunnel that will cover the back face.**)
5. Cut the tunnel ends to the desired shape and lightly sand its surface. Clean the area with acetone or similar where you are going to apply fibreglass. (**NB: Do not cast or add fibreglass to the area were the thruster will be placed.**)
6. Cast the tunnel to the inside of the hull, use at least eight layers of 300g fibreglass and resin, preferably alternating mat and rowing types of fibreglass. To round the tunnel ends to a 10% radius make further layers inside to preserve the desired hull thickness.

(NB: Ensure gaps between the tunnel and the hull are completely filled with resin/ fibreglass. In areas where you can not access to make layers of resin/ fibreglass, a resin/ fibreglass mixture must be used in that area.)

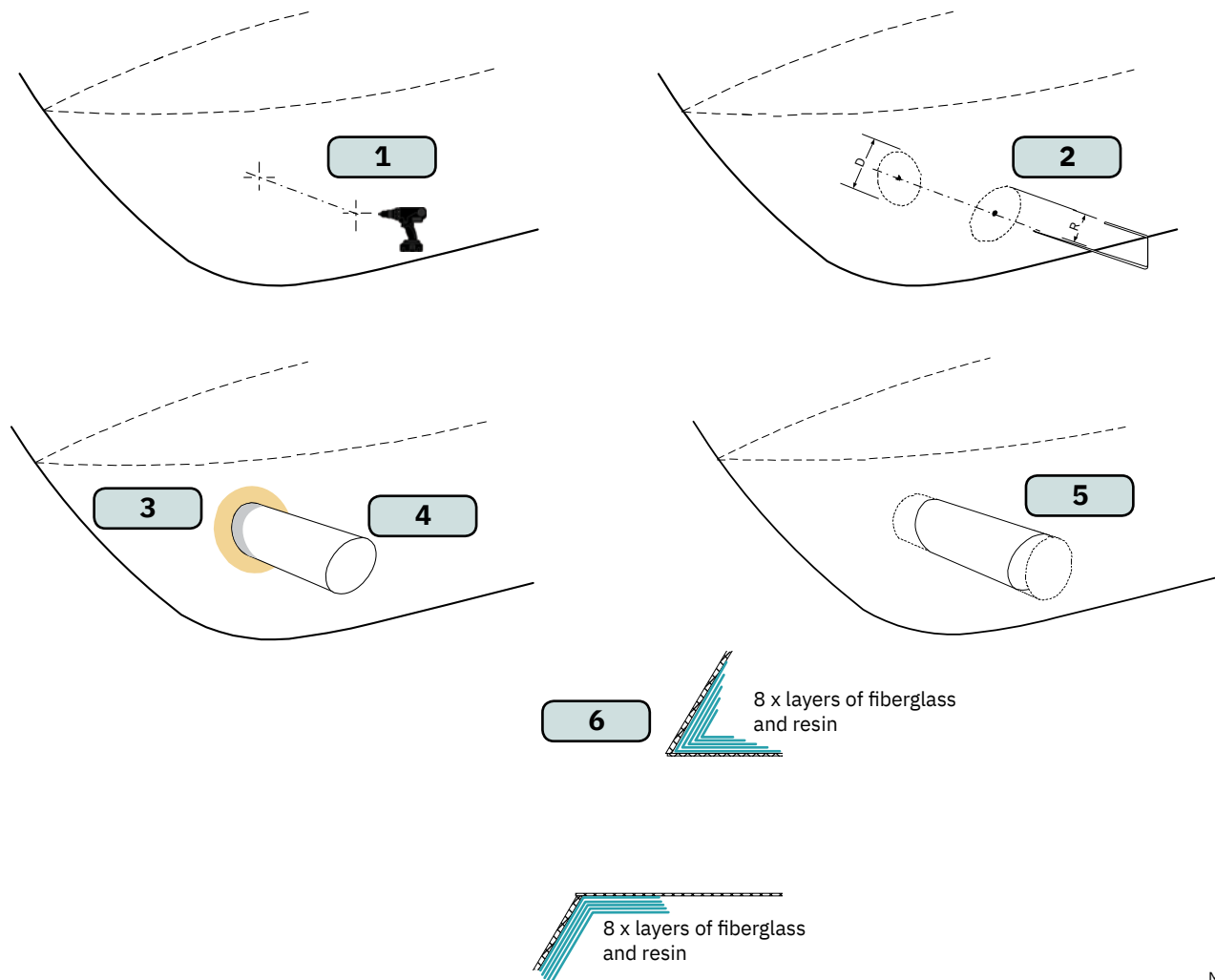

With tunnel installed and cast.

1. Round the edges with a radius of 10% of the tunnel diameter.
2. For steel/ aluminium hulls make a slope with a length of 10-15% of the tunnel diameter.
(NB: If this is not possible, round the tunnel end as much as possible.)
3. Additionally cast two layers on the outside of the tunnel/ hull in a 10cm area
4. Follow the same method if making the deflector/ spoiler.

You must apply gel coat to areas you have grounded/ moulded to make waterproof. These areas allow water access to the hull which is typically not waterproof without these applications outside. **(NB: All original Side-Power tunnels are fully waterproof when delivered except in the areas where you have cut and bonded it to the hull.)**

IMPORTANT
 Avoid all casting where the motor-bracket is to be placed, as this will cause misfit and possible failure to the gear house.

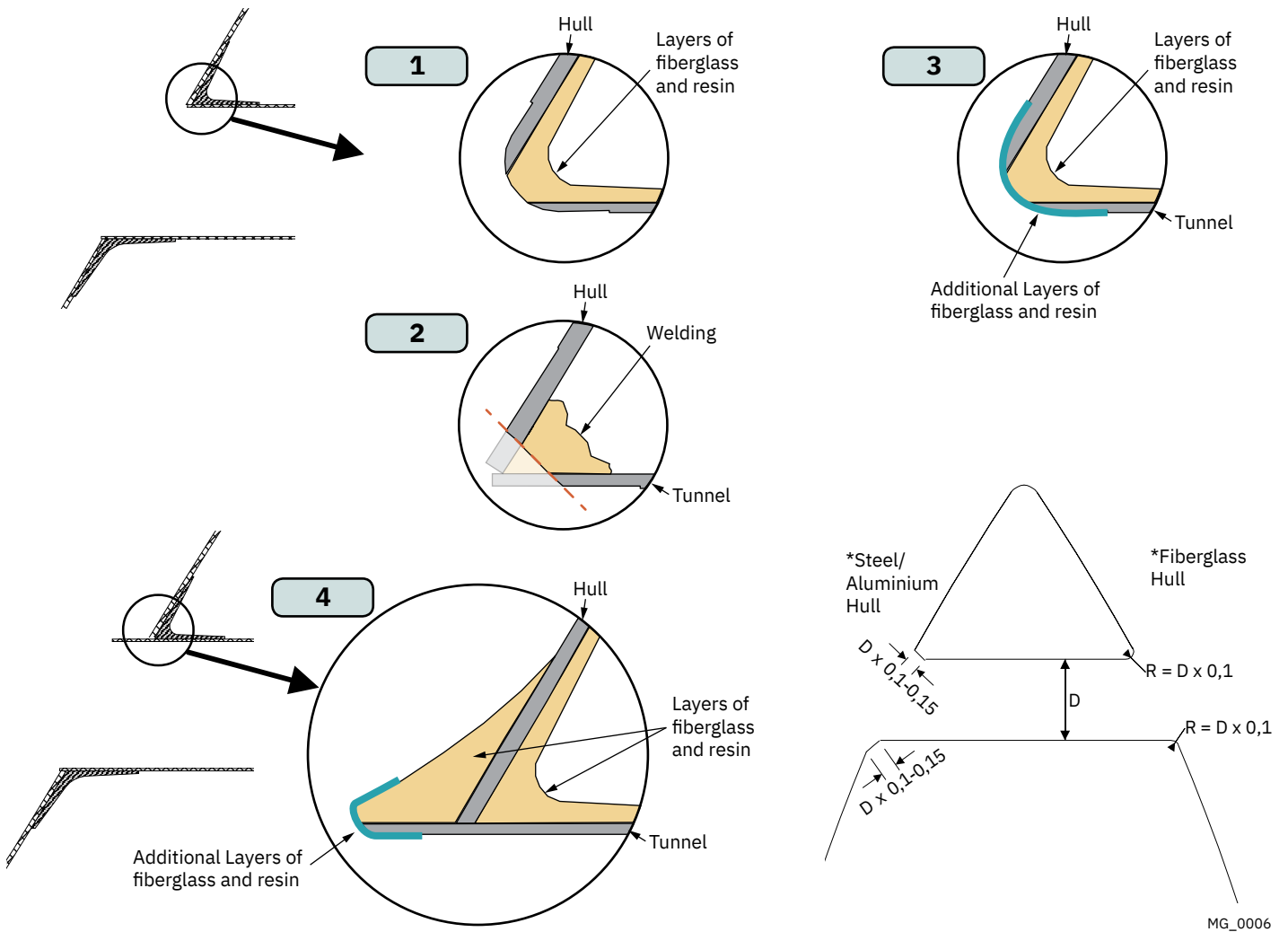

For **Stern Thruster** installation please refer to the supplied manual in your Sleipner product delivery

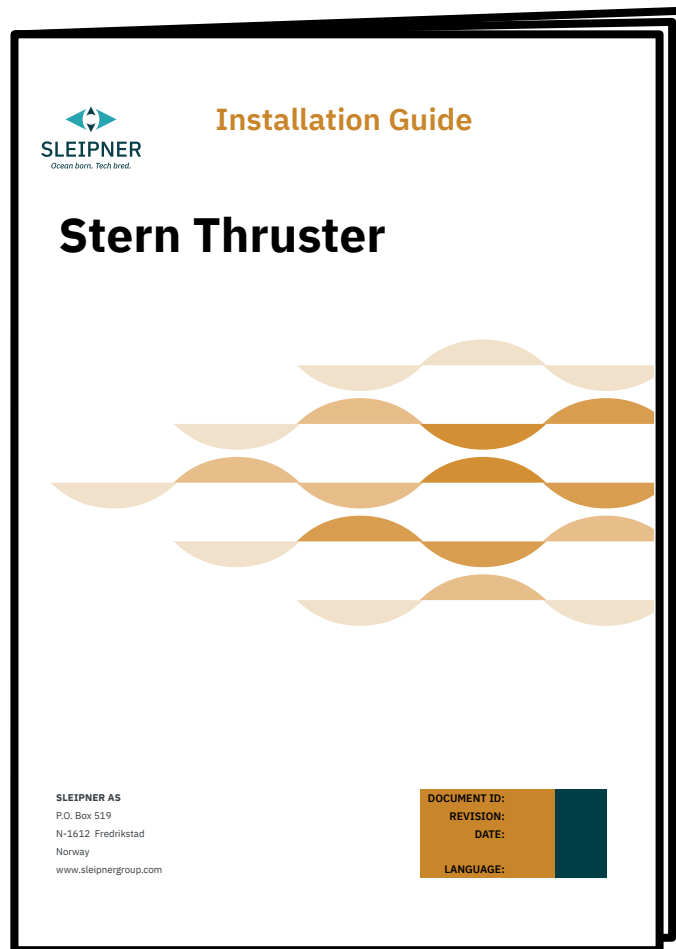

! Please refer to the graphic for special considerations relating to your model !

1. Mark the tunnel centreline and the boat's centreline. **(NB: Install the gear leg and propeller as shown above for the thrust direction to correspond with the control panel. Position gear leg with the P-mark facing port and the S-mark facing starboard.)**
2. Use the gasket or template (recommended) to mark the hole centres and double-check the measurements. The centre hole MUST be placed using the boat centreline as shown above. **(NB: All holes must be in-line with the tunnels' centreline for correct installation, clearance between the propeller and the tunnel is minimal.)**
3. Smooth the surface of the tunnel. A rough surface will cause possible failure/movement of the gear leg. The motor bracket must rest steadily on the tunnel.
4. Drill the main centre hole followed by the two screw-holes.
5. Place the gear leg (without the propeller) with the gasket on inside the tunnel. Place the propeller on the gear leg to ensure it is centred and rotates freely with the same clearance from each blade to the tunnel wall. Place top motor bracket to measure the drive shaft has come through the motor bracket at the correct height. Remove the gear leg and propeller for final installation.
6. Apply appropriate sealant to both sides of the gasket and place on the gear leg. Place the gear leg in the tunnel (without the propeller).
7. Install the top motor bracket and gear leg gently together. Use appropriate sealant to ensure that no leakages occur. **(NB: See your sealant data sheet for the correct application process.)**
8. Fasten the gear leg and the motor bracket with the bolts provided. Fasten to torque as shown above.

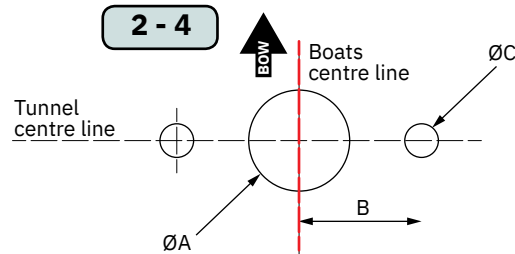
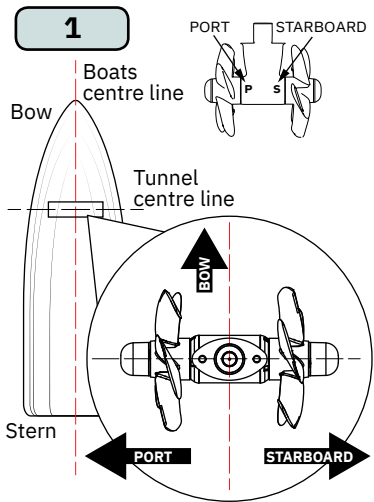

Measurement Description	SH 100		SH 160 SH 240	
	mm	inch	mm	inch
ØA	34	1.33	47	1.85
B	28	1.1	40	1.57
ØC	9	0.35	12	0.43

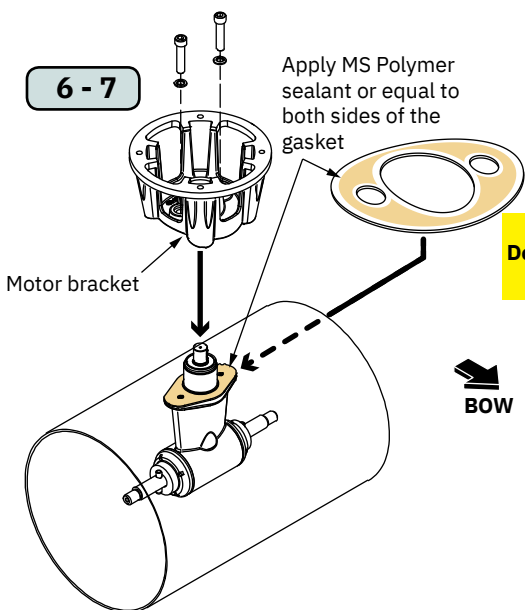
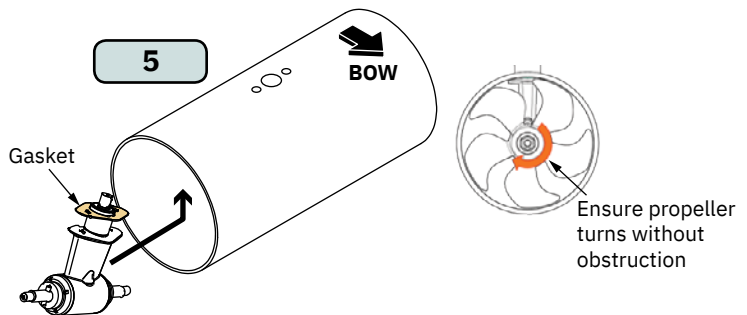

IMPORTANT
Do not apply sealant to the holes.

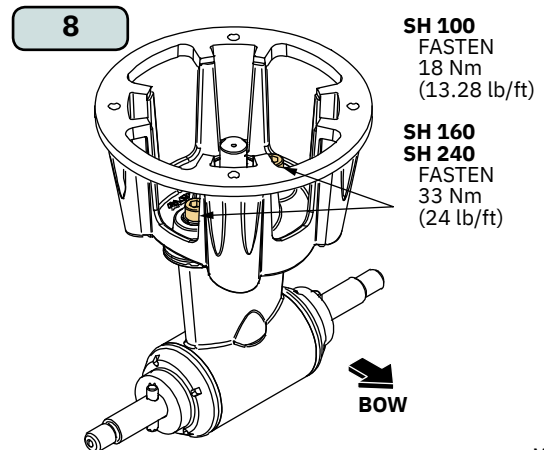

! Please refer to the graphic for special considerations relating to your model !

1. Centre the drive pin and Insert the propeller onto the shaft spline. Rotate the propeller until the drive pin aligns with the internal slot in the propeller.
2. Insert the washer to the end of the shaft spline. Tighten with the propeller lock-nut.
3. Insert the anode to the end of the propeller and tighten the anode holding screw. Apply a thread glue (Loctite 243 or similar) to ensure that the anode holding screw does not unscrew itself from during the rotation of the propeller.
4. Apply anti-fouling to the gear leg and propeller. Do not apply anti-fouling to any rubber elements of the gear leg or anodes.

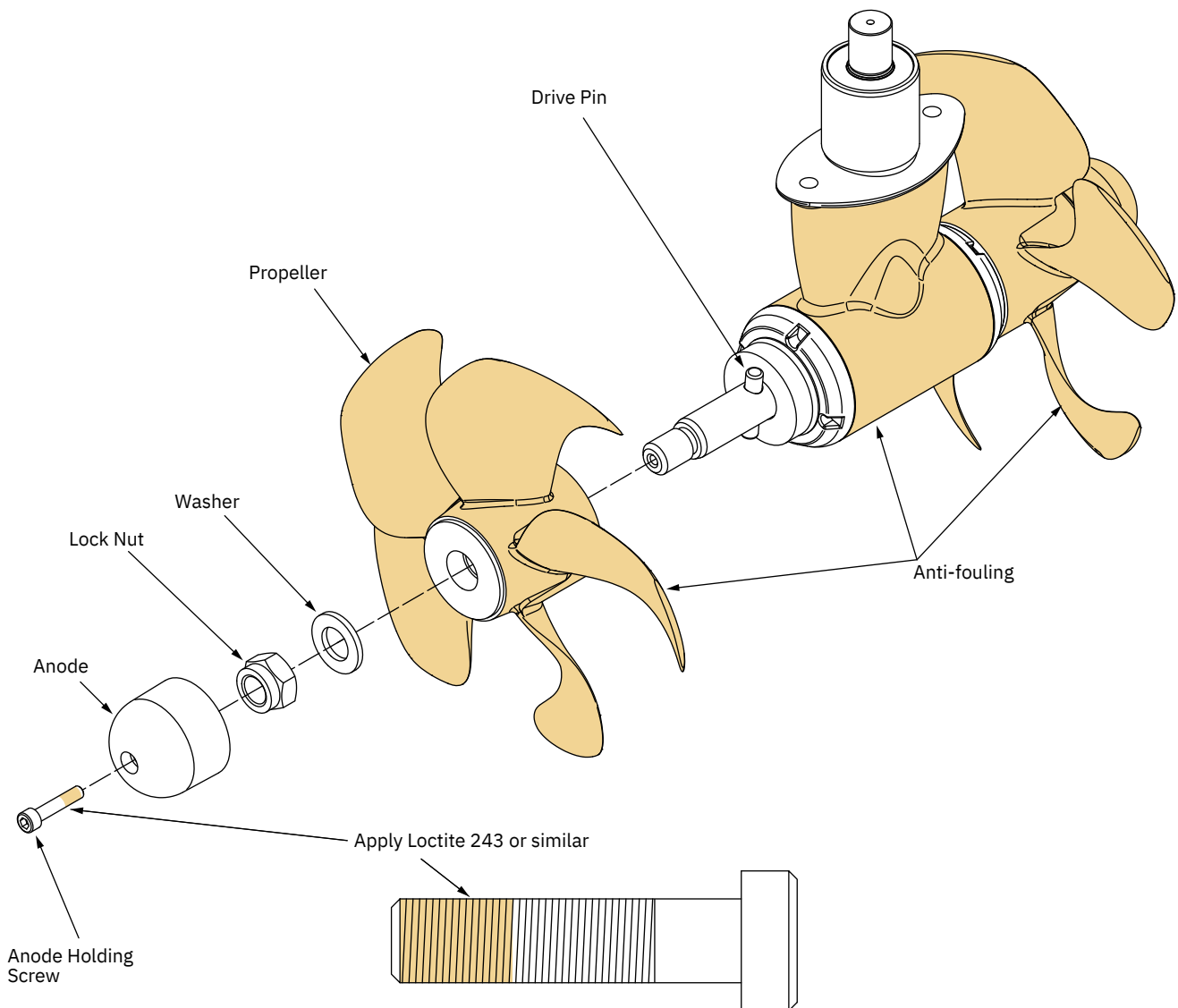

MG_0033

! Please refer to the graphic for special considerations relating to your model !

1. Install the motor onto the motor bracket ensuring the couplings are engaged together correctly (top and bottom). **(NB: The motor can be placed in all directions on the motor bracket. However, ensure the hose terminals are accessible for connection installation later.)**
2. Apply seawater resistant grease on the shafts before fitting the flexible coupling. Fasten the bolts holding the motor to the motor bracket with the above torque.
3. Check the drive shafts are engaged by rotating the propeller. **(NB: Rotating the propellers can be hard due to the gear reduction and the motor, however the propeller must be able to rotate via hand power.)**

IMPORTANT

The hydraulic motor must be covered to avoid dust from fabrication/ maintenance operation entering the motor hose pipes.

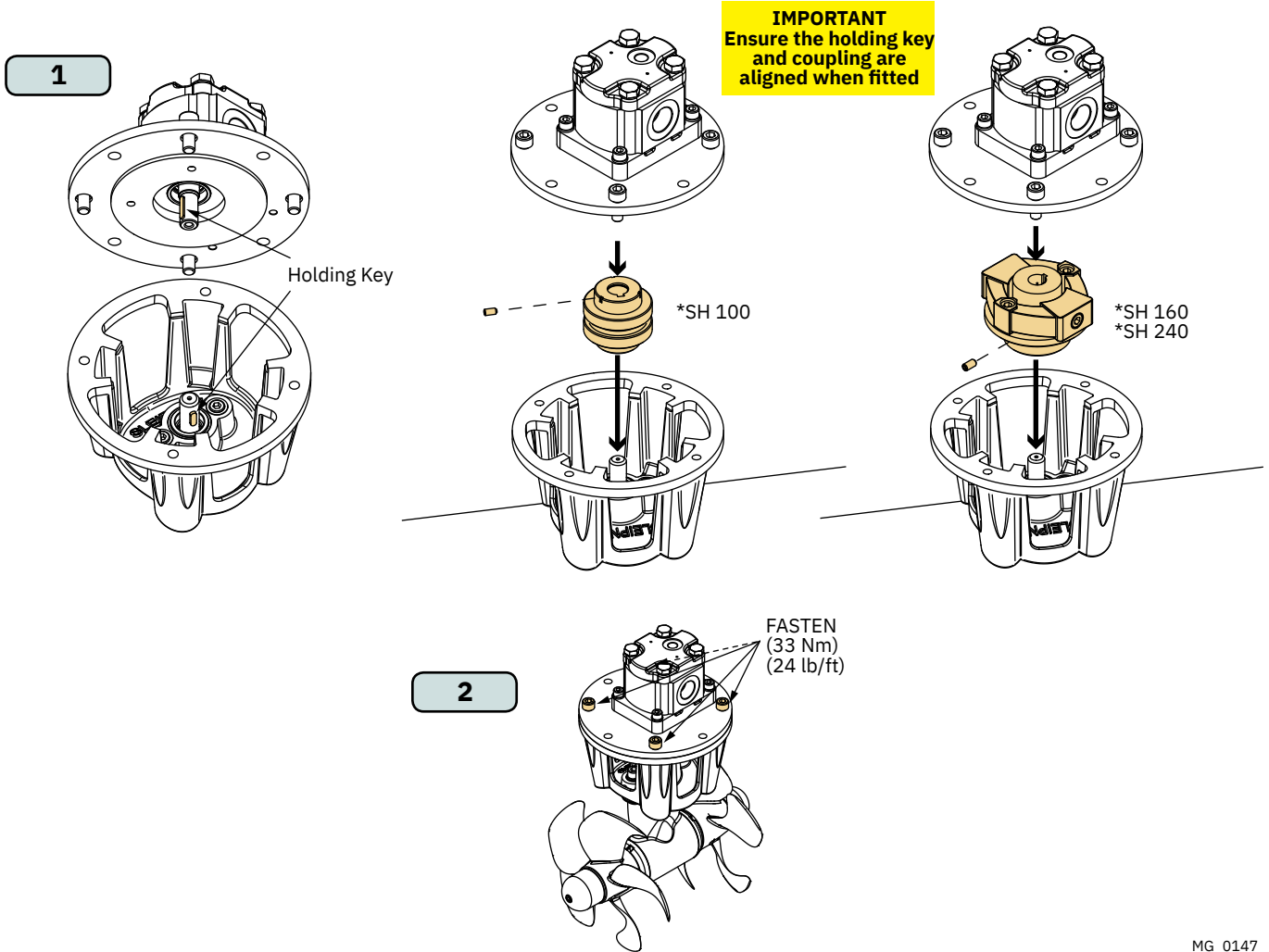

MG_0147

S-Link is a CAN-based control system used for communication between Sleipner products installed on a vessel. The system uses BACKBONE Cables as a common power and communication bus with separate SPUR Cables to each connected unit. Units with low power consumption are powered directly from the S-Link bus therefore one power cable must be connected to the BACKBONE Cable through a T-Connector. The S-Link cables should be installed such that sharp bend radius is avoided. Locking mechanism of connectors must be fully closed. Cables, T-Connectors and Extenders should not be located such that they are permanently immersed in water or other fluids.

Main advantages of S-Link system:

- Compact and waterproof plugs.
- BACKBONE and SPUR Cables have different colour coding and keying to ensure correct and easy installation. BACKBONE Cables have blue connectors and SPUR Cables have green connectors.
- Different cable lengths and BACKBONE Extenders makes the system scalable and flexible to install.

Installation of S-Link cables:

Select appropriate cables to keep the length of BACKBONE- and SPUR Cables to a minimum. The S-Link cables should be installed to ensure sharp bend radius's is avoided. The locking mechanism on connectors must be fully closed. Cables, T-Connectors and Extenders should not be located so that they are permanently immersed in water or other fluids.

The POWER Cable should ideally be connected around the middle of the BACKBONE Cable to ensure an equal voltage drop at each end of the BACKBONE Cable. The yellow and black wire in the POWER Cable shall be connected to GND and the red wire connected to +12VDC or +24VDC.

To reduce the risk of interference, avoid routing the S-Link cables close to equipment such as radio transmitters, antennas or high voltage cables. The backbone must be terminated at each end with the END Terminator.

Spur cables can be left unterminated to prepare for the installation of future additional equipment. In such cases, ensure to protect open connectors from water and moisture to avoid corrosion in the connectors.

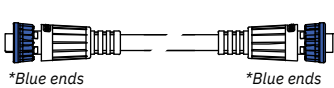

BACKBONE Cable
Forms the communication and power bus throughout a vessel. Available in different standard lengths.

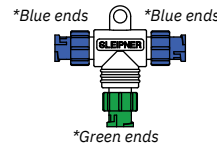

T-Connector
Used for connection of SPUR or POWER Cable to the BACKBONE Cable. One T-Connector for each connected cable.

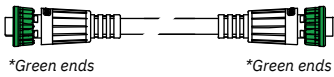

SPUR Cable
Used to connect S-Link compliant products to the backbone cable. One SPUR Cable must be used for each connected component, with no exceptions. Recommended to be as short as practically possible. Available in different standard lengths.



BACKBONE Extender
Connects two BACKBONE Cables to extend the length.

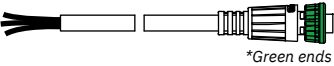

POWER Cable
Must be one in each system. Connects BACKBONE Cable to the power supply.



END Terminator
Must be one at each end of the BACKBONE bus.

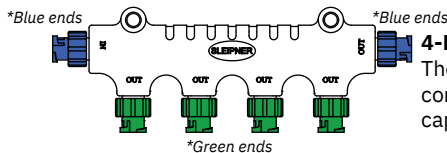

4-Port T-Connector
The 4-PORT T-connector allows multiple SPUR Cables to be connected. The 4-PORT T-connector comes with two sealing caps to protect unused ports.

S-Link installation example

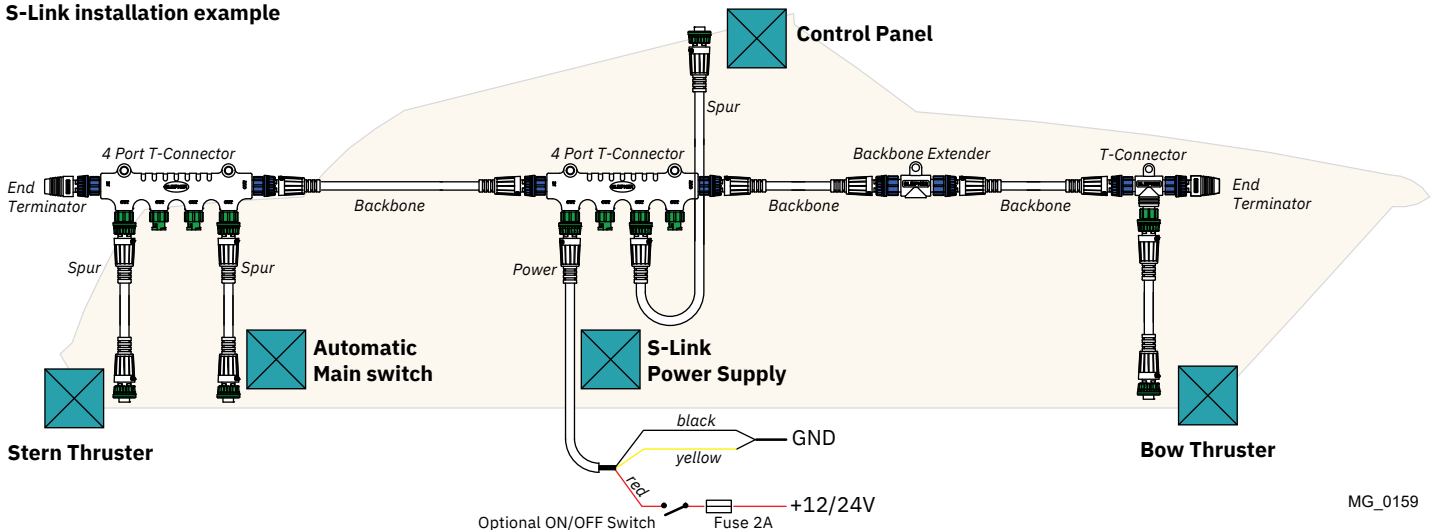

For **Control Panel** installation please refer to the supplied manual in your Sleipner product delivery



- Propeller is fastened correctly to the shaft.
- Propeller turns freely in tunnel.
- Lower-unit is filled with gear oil.
- Oil-drain screw is tightened and the copper seal is present.
- The anode holding screw is tightened well with thread glue.
- Anti-fouling have been applied to the gear house and propeller but NOT on the anode or the gear house lid where the propeller is fastened.
- Oil tank is fitted above the waterline as required and filled with gear oil.
- Correct drive direction as per control panel.
- The bolts holding the gear house and motor bracket together are tightened correctly.
- The bolts holding the motor to its bracket are tightened correctly.

The thruster has been installed as per the instructions in this manual and all points in checklist above have been controlled.

Signed:

Date:

Extra pre-delivery tests by installer / yard who does not use other quality control systems !

Thruster type:

Serial number:.....

Date of delivery:.....

Correct drive direction as per control panel:

The compartment for the thruster has been isolated from general bilge water and has no obvious or suspected risks for flooding:

.....
.....
.....

Other comments by installer:

.....

Find your local professional dealer from our certified worldwide network for expert service and support.

visit our website www.sleipnergrou.com/support

Product Spare Parts and Additional Resources

For additional supporting documentation, we advise you to visit our website www.sleipnergrou.com and find your Sleipner product.

Warranty statement

1. Sleipner Motor AS (The "Warrantor") warrants that the equipment (parts, materials and embedded software of products) manufactured by the Warrantor is free from defects in workmanship and materials for the purpose for which the equipment is intended and under normal use and service (the "Warranty").
2. This Warranty is in effect for two years (Leisure Use) or one year (Commercial and other Non-leisure Use) from the date of purchase by the end user (for demonstration vessels, the dealer is deemed as end user).
3. This Warranty is transferable and covers the equipment for the specified warranty period.
4. The warranty does not apply to defects or damages caused by faulty installation or hook-up, abuse or misuse of the equipment including exposure to excessive heat, salt or fresh water spray, or water immersion except for equipment specifically designed as waterproof.
5. In case the equipment seems to be defective, the warranty holder (the "Claimant") must do the following to make a claim:
 - (a) Contact the dealer or service centre where the equipment was purchased and make the claim. Alternatively, the Claimant can make the claim to a dealer or service centre found at www.sleipnergrou.com. The Claimant must present a detailed written statement of the nature and circumstances of the defect, to the best of the Claimant's knowledge, including product identification and serial nbr., the date and place of purchase and the name and address of the installer. Proof of purchase date should be included with the claim, to verify that the warranty period has not expired;
 - (b) Make the equipment available for troubleshooting and repair, with direct and workable access, including dismantling of furnishings or similar, if any, either at the premises of the Warrantor or an authorised service representative approved by the Warrantor. Equipment can only be returned to the Warrantor or an authorised service representative for repair following a pre-approval by the Warrantor's Help Desk and if so, with the Return Authorisation Number visible postage/shipping prepaid and at the expense of the Claimant.
6. Examination and handling of the warranty claim:
 - (a) If upon the Warrantor's or authorised service Representative's examination, the defect is determined to result from defective material or workmanship in the warranty period, the equipment will be repaired or replaced at the Warrantor's option without charge, and returned to the Purchaser at the Warrantor's expense. If, on the other hand, the claim is determined to result from circumstances such as described in section 4 above or a result of wear and tear exceeding that for which the equipment is intended (e.g. commercial use of equipment intended for leisure use), the costs for the troubleshooting and repair shall be borne by the Claimant;
 - (b) No refund of the purchase price will be granted to the Claimant, unless the Warrantor is unable to remedy the defect after having a reasonable number of opportunities to do so. In the event that attempts to remedy the defect have failed, the Claimant may claim a refund of the purchase price, provided that the Claimant submits a statement in writing from a professional boating equipment supplier that the installation instructions of the Installation and Operation Manual have been complied with and that the defect remains.
7. Warranty service shall be performed only by the Warrantor, or an authorised service representative, and any attempt to remedy the defect by anyone else shall render this warranty void.
8. No other warranty is given beyond those described above, implied or otherwise, including any implied warranty of merchantability, fitness for a particular purpose other than the purpose for which the equipment is intended, and any other obligations on the part of the Warrantor or its employees and representatives.
9. There shall be no responsibility or liability whatsoever on the part of the Warrantor or its employees and representatives based on this Warranty for injury to any person or persons, or damage to property, loss of income or profit, or any other incidental, consequential or resulting damage or cost claimed to have been incurred through the use or sale of the equipment, including any possible failure or malfunction of the equipment or damages arising from collision with other vessels or objects.
10. This warranty gives you specific legal rights, and you may also have other rights which vary from country to country.

Patents

At Sleipner we continually reinvest to develop and offer the latest technology in marine advancements. To see the many unique designs we have patented visit our website www.sleipnergrou.com/patents

© Copyright Sleipner Motor AS, 2021

The information given in the document was correct at the time it was published.

However, Sleipner Motor AS can not accept liability for any inaccuracies or omissions it may contain. Continuous product improvement may change the product specifications without notice.

Therefore, Sleipner Motor AS can not accept liability for any possible differences between product and document.

Register your product and learn more at www.sleipnergroun.com



SLEIPNER AS

P.O. Box 519

N-1612 Fredrikstad

Norway

www.sleipnergroun.com

Made in Norway



Keep this
manual onboard!



User Manual

For Thruster Models
SH Hydraulic



SLEIPNER AS

P.O. Box 519

N-1612 Fredrikstad

Norway

www.sleipnergroup.com

DOCUMENT ID: 6572

REVISION: 4

DATE: 2022

LANGUAGE: EN

**U
M**

To download your language go to www.sleipnergroup.com

Contents

User Manual

Responsibility of the user operating thrusters	3
General user considerations and precautions for hydraulic thrusters	3
User operation	4
Compatible control device products	4
Control panel	5
Maintenance	6 - 7
Basic troubleshooting	8
Seasonal checklist	9
Service and Support.....	10
Product Spare Parts and Additional Resources.....	10
Warranty Statement.....	10

Products

SH1000/513-BA45 - SH1000 Tunnel thruster, Ø513mm
SH100/185T-U06 - SH100 Tunnel thruster, U06
SH100/185T-U10 - SH100 Tunnel thruster, U10
SH160/215T-U14 - SH160 Tunnel thruster, U14
SH160/215T-U06 - SH160 Tunnel thruster, U06
SH240/250TC-U08 - SH240 Tunnel thruster, U08
SH240/250TC-U10 - SH240 Tunnel thruster, U10
SH240/250TC-U19 - SH240 Tunnel thruster, U19
SH320/300TC-U16 - SH320 Tunnel thruster, U16
SH320/300TC-U19 - SH320 Tunnel thruster, U19 [Archived]
SH320/300TC-U08 - SH320 Tunnel thruster, U8
SH320/300TC-U23 - SH320 Tunnel thruster, U23
SH320/300TC-U14 - SH320 Tunnel thruster, U14
SH320/300TC-U11 - SH320 Tunnel thruster, U11
SH320/300TC-BA19 - SH320 Tunnel thruster, BA19
SH320/300TC-BA16 - SH320 Tunnel thruster, BA16
SH420/386TC-U37 - SH420 Tunnel thruster, U37
SH420/386TC-BA40 - SH420 Tunnel thruster, BA40
SH420/386TC-BA32 - SH420 Tunnel thruster, BA32
SH420/386TC-U33 - SH420 Tunnel thruster, U33
SH420/386TC-U26 - SH420 Tunnel thruster, U26
SH420/386TC-BA40-S - SH420 Tunnel thruster, BA40
SH420/386TC-U29 - SH420 Tunnel thruster, U29
SH550/BA40-S - Hydraulikk thruster, >550kg
SH550/386TC-P52 - SH550 Tunnel thruster, P52
SH550/386TC-BA60 - SH550 Tunnel thruster, BA60
SH550/386TC-BA32 - SH550 Tunnel thruster, BA32
SH550/386TC-BA40 - SH550 Tunnel thruster, BA40
SH550/386TC-U50 - *Hydraulikk thruster >550-U50
SH550/386TC-U33 - SH550 Tunnel thruster, U33
SH550/386TC-U37 - SH550 Tunnel thruster, U37
SH550/386TC-BA40-S - SH550 Tunnel thruster, BA40
SH550/386TC-BA75 - SH550 Tunnel thruster, BA75
SH550/386TC-G45 - SH550 Tunnel thruster, G45
SH700/412-BA60 - SH700 Tunnel thruster, BA60
SH700/412-BA75 - SH700 Tunnel thruster, BA75
SH700/412-BA45 - SH700 Tunnel thruster, BA45
SH700/412-BA56 - SH700 Tunnel thruster, BA56 [Archived]
SH1000/513-BA110 - * BRUK SH1000/513-BA110D13
SH1000/513-G80 - SH1000 Tunnel thruster, G80
SH1000/513-BA125 - SH1000 Tunnel thruster, BA125
SH1000/513-G75 - SH1000 Tunnel thruster, G75
SH1000/513-BA80 - SH1000 Tunnel thruster, BA80
SH1000/513-G70 - SH1000 Tunnel thruster, G70
SH1000/513-BA60 - SH1000 Tunnel thruster, BA60
SH1000/513-BA110D13 - SH1000 Tunnel thruster, BA110
SH1400/610-BA160 - SH1400 Tunnel thruster, BA160
SH1400/610-BA125 - SH1400 Tunnel thruster, BA125
SH1400/610-BA80 - SH1400 Tunnel thruster, BA80
SH1400/610-BA180 - SH1400 Tunnel thruster, BA180
SH1400/610-BA110 - SH1400 Tunnel thruster, BA110
SH1400/610-BA150 - SH1400 Tunnel thruster, BA150 [Archived]
SH1400/610-BA080 - SH1400 Tunnel thruster, BA80
SH100/185T-U11 - SH100 Tunnel thruster, U11
SH160/215T-U08 - SH160 Tunnel thruster, U08 [Archived]
SH1000/513-BA75 - SH1000 Tunnel thruster, BA75
SH160/215T-U11 - SH160 Tunnel thruster, U11 [Archived]
SH320/300TC-U10 - SH320 Tunnel thruster, U10
SH550/386TC-BA56 - SH550 Tunnel thruster, BA56
SH1000/513-BA90 - SH1000 Tunnel thruster, BA90
SH100/185T-U08 - SH100 Tunnel thruster, U08 [Archived]
SH160/215T-U10 - SH160 Tunnel thruster, U10
SH240/250TC-U14 - SH240 Tunnel thruster, U14
SH240/250TC-U16 - SH240 Tunnel thruster, U16
SH240/250TC-U11 - SH240 Tunnel thruster, U11
SH550/386TC-BA45 - SH550 Tunnel thruster, BA45

Failure to follow the considerations and precautions can cause serious injury, damage and will render all warranties given by Sleipner Motor as VOID.

MC_0411

General Operation Considerations and Precautions Guidelines

MC_0444

For the operation of thrusters

MC_0418

Never use thrusters when close to objects, persons or animals in the water. The thruster will draw objects into the tunnel and the rotating propellers. This will cause serious injuries and damage the thruster.

Always turn the main power switch off before touching any part of the thruster. An incidental start while touching moving parts can cause serious injuries.

It is the owner, captains or other responsible parties full responsibility to assess the risk of any unexpected incidents on the vessel. If the thruster stops giving thrust for some reason while manoeuvring you must have considered a plan on how to avoid damage to persons or other objects.

- Always turn the control device off when the thruster is not in use or when leaving the boat.
- When leaving the boat always turn off the main power switch for the thruster.
- Never use thrusters out of water.
- If the thruster stops giving thrust while running, there is possibly a problem in the drive system. You must immediately stop running the thruster and turn it off. Running the thruster for more than a few seconds without resistance from the propeller can cause serious damage to the thruster.
- If two panels are operated with conflicting directions at the same time the thruster will not run. If both are operated in the same direction, the thruster will run in this direction.
- If you notice any faults with the thruster switch it off to avoid further damage.
- The primary purpose of the thruster is to manoeuvre or dock the vessel. Forward or reverse speed must not exceed 4 knots when operated.

For the operation of hydraulic motor thrusters

MC_0421

- If the performance of the thruster is reduced check the hydraulic system or check the tunnel for marine growth.

! Please refer to the graphic for special considerations relating to your model !

The following is an operation guide to ALL Sleipner control products. Ensure to familiarise yourself with the functionality and operation of your specific control device.

Take time to practice operation in open water to become familiar with the thruster and to avoid damages to your boat or people.

General operation

1. Turn on the main power switch for the bow thruster. *(NB: Always turn off the main power switch when not on-board.)*
2. Turn on the control panel by pushing the/ both "ON" button(s) on the original Sleipner panel simultaneously.
*Turn off the control panel by pushing the "OFF" button
3. To Turn the bow/ stern in the desired direction:

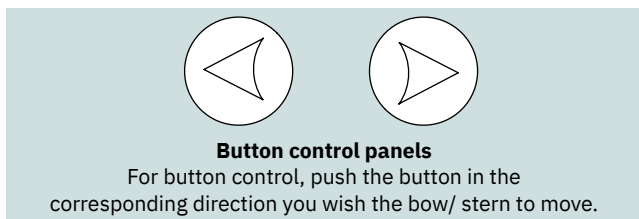

(NB: If equipped for proportional control move the joystick equivalent to the amount of thrust you intend to receive.)

* For other controls like foot switches or toggle-switches please refer to that products user manual for detailed operational use.

Hold functionality

If equipped with 'hold' functionality push the button in the corresponding direction you wish the thrusters to engage a holding pattern:

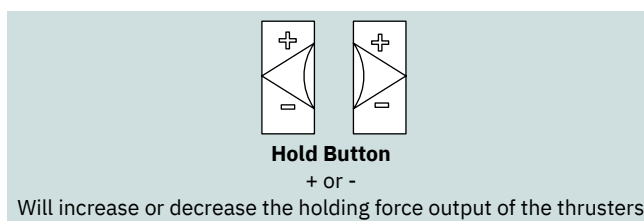

Operating a combined bow and stern thruster

The combination of a bow and stern thruster offers total manoeuvrability to move the bow and the stern separately from each other or in unison. This enables the boat to move sideways in both directions or turn the boat around a 360° axis while staying stationary.

Remote controls

Ensure the remote control is held in the same direction as the boat during operation.

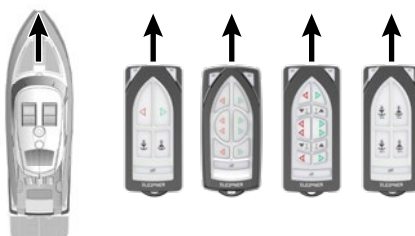

Drift

Depending on the sideways speed of the bow/ stern, you must disengage the control device shortly before the vessel is in the desired position.

(NB: Be aware the boat will continue to move after disengaging the thruster control.)

At any significant cruising speed (+1-2 kn) the side thruster will have little effect to steer the vessel.

Compatible Control Device Products

! Please refer to the graphic for special considerations relating to your model !

ON/ OFF CONTROL PANEL



REMOTE CONTROL



For additional information refer to your control device manual



Control Panel

Activating the bow thruster

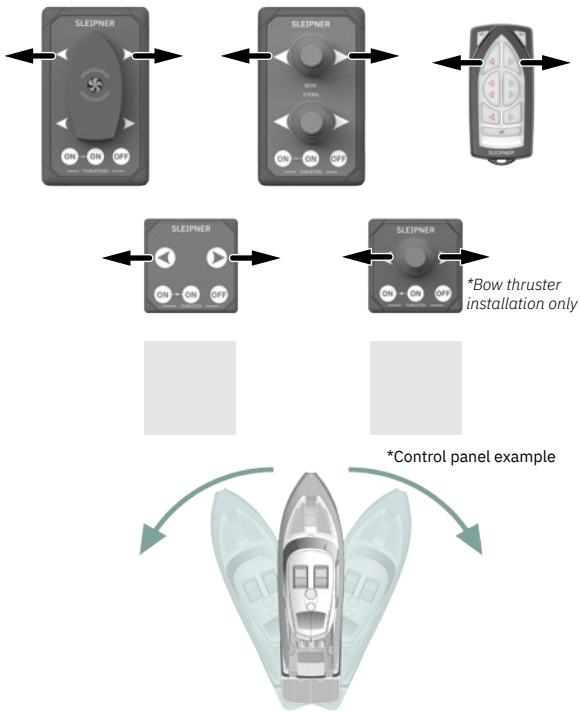

Activating the stern thruster

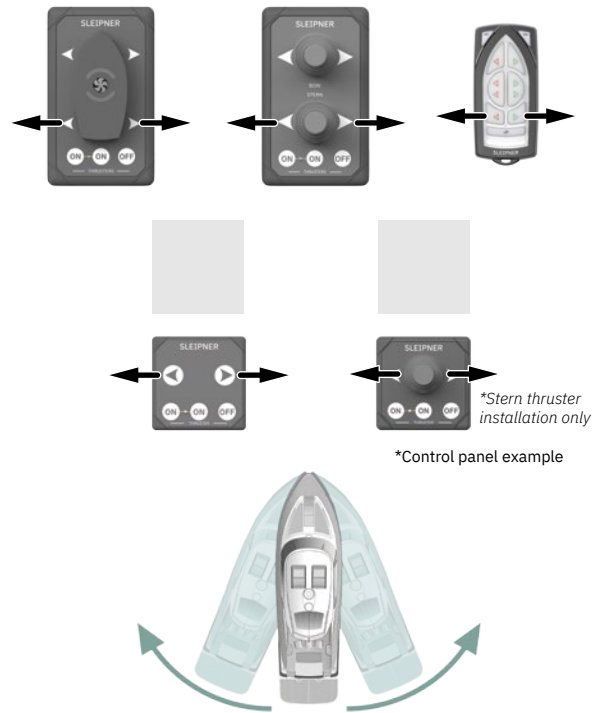

Activating both bow and stern thruster to push the boat sideways

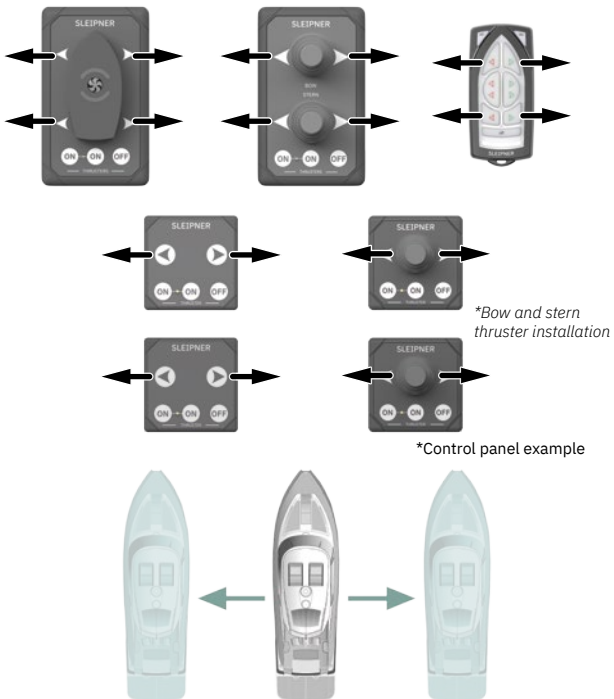

Activating both bow and stern thruster to rotate the boat on axis

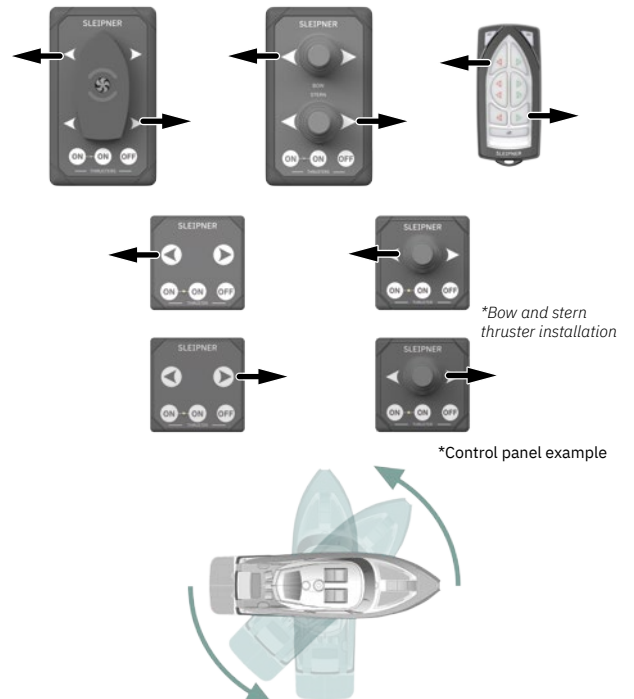

! Please refer to the graphic for special considerations relating to your model !

As a part of the seasonal service of your Thruster before every season, always check that:

In Water/ Out of the Water

- The area around the thruster inside the boat is clean and dry. Ensure there are no signs of water or oil leaks.
- All electrical connections are clean and fastened firmly.
- Ensure that your batteries are in good condition.

Out of Water

- Check the propeller(s) or tunnel for any damage for example impact damage.
- The propeller(s) is fastened securely to the gear leg.
- Check all components of thruster are fastened securely.
- Clean the tunnel and gear leg from marine growth.
- Paint the propeller and gear leg with anti-fouling before every season to keep it clean from sea growth. **(NB: Never paint the anode, rubber seals or propeller shaft. Ensure paint does not enter the space between the propeller and the gear leg.)**
- Change the anode before every season, or when half the anode has eroded. Always use a sealant or thread glue on the securing screw to ensure that it does not fall off.
- Ensure propellers are attached correctly. **(NB: Counter rotating models use a left hand/ right hand propeller.)**
- If an external oil tank is installed with your model, ensure the oil level remains the same.

SH
* 100
* 160
* 240

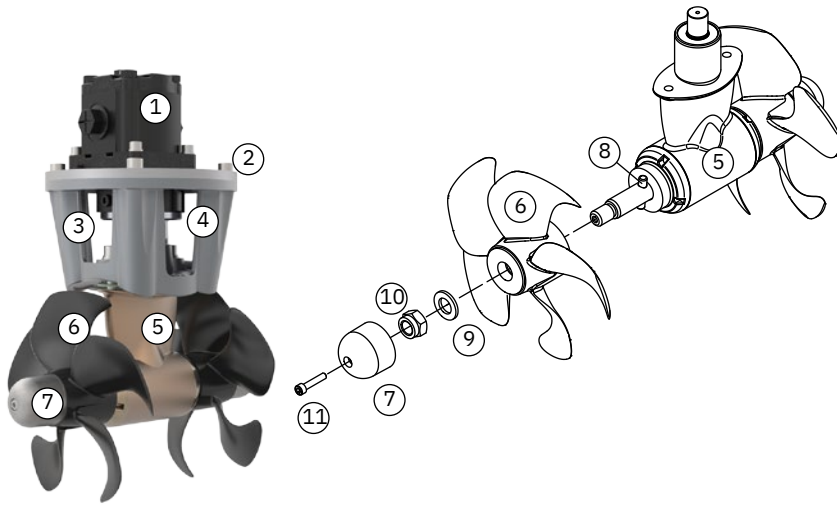

SH
* 320

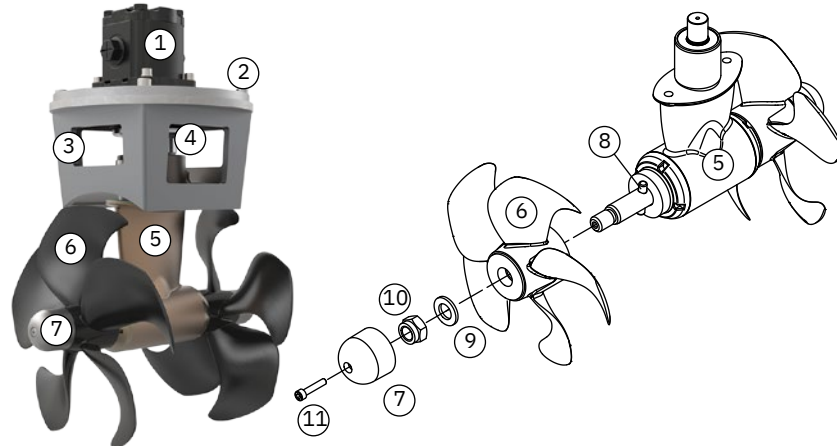

SH
* 420
* 550

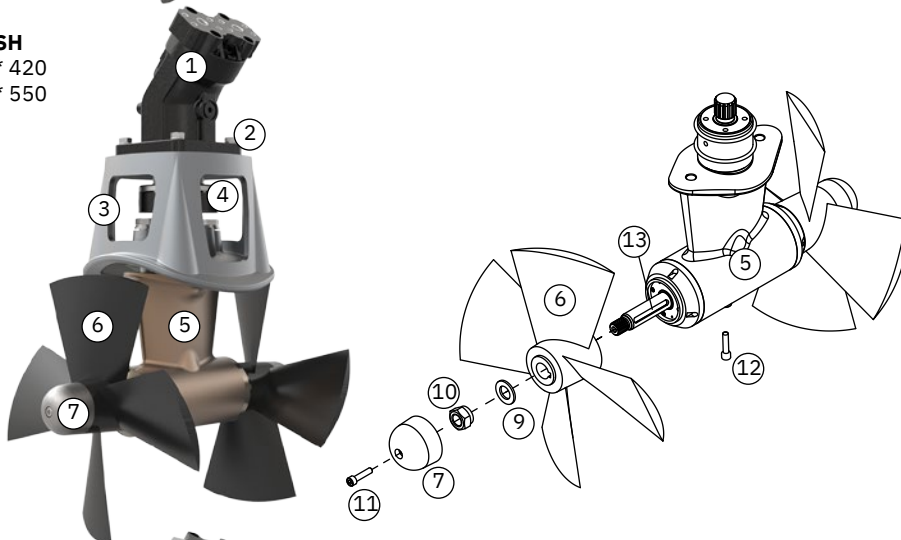

SH
* 700
* 1000
* 1400

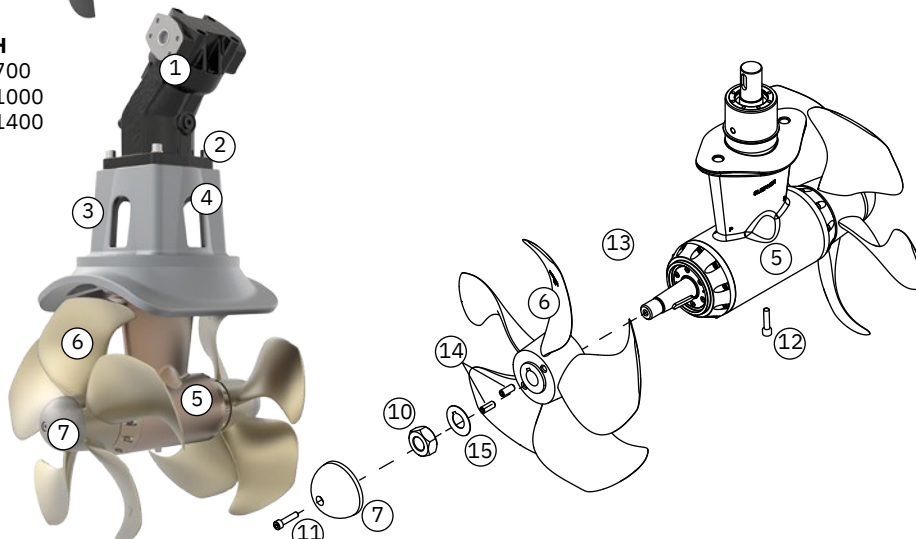

KEY:

- 1. Hydraulic Motor
- 2. Mounting Plate
- 3. Motor bracket
- 4. Flexible coupling
- 5. Gear Leg
- 6. Propeller
- 7. Anode
- 8. Drive pin
- 9. Washer
- 10. Lock Nut
- 11. Fastening Screw for anode
- 12. Oil drain screw
- 13. Shaft Key
- 14. Anode pins
- 15. Locking Washer

Before seeking assistance from the website help desk from your Side-Power dealer/ distributor, please perform these tests.

(NB: If you are unable to understand what to check, you must consult a Side Power distributor.)

CHECK	SOLUTION
The motor runs, but there is no thrust	
Check propellers are fitted, fastened correctly and not damaged on the prop shaft.	Re-fasten or replace if necessary
On counter rotating models ensure LH and RH propellers are installed correctly	Install correctly
Check the flexible coupling between the motor and drive shaft is fitted correctly and not damaged.	Replace if necessary
Check the gears are not damaged.	Replace if necessary
The thrusters performance is reduced	
Check the propeller, gear house and tunnel are free from growth/ barnacles or debris and damage.	If there is growth in the tunnel, this will disturb/ block the water flow and significantly reduce performance
Check oil pressure and levels.	Fill if necessary

CHECK TO PERFORM	DATE											
The thruster components are fastened securely.												
The area around the thruster is clean and dry. If there are signs of water or oil leaks												
Paint the propeller and gear leg with anti-fouling.												
Batteries are in good condition.												
All electrical connections are clean and fastened firmly.												
Change the anode.												
Check oil in the oil reservoir.												

Find your local professional dealer from our certified worldwide network for expert service and support.

visit our website www.sleipnergrou.com/support

Product Spare Parts and Additional Resources

For additional supporting documentation, we advise you to visit our website www.sleipnergrou.com and find your Sleipner product.

Warranty statement

1. Sleipner Motor AS (The “Warrantor”) warrants that the equipment (parts, materials and embedded software of products) manufactured by the Warrantor is free from defects in workmanship and materials for the purpose for which the equipment is intended and under normal use and service (the “Warranty”).
2. This Warranty is in effect for two years (Leisure Use) or one year (Commercial and other Non-leisure Use) from the date of purchase by the end user (for demonstration vessels, the dealer is deemed as end user).
3. This Warranty is transferable and covers the equipment for the specified warranty period.
4. The warranty does not apply to defects or damages caused by faulty installation or hook-up, abuse or misuse of the equipment including exposure to excessive heat, salt or fresh water spray, or water immersion except for equipment specifically designed as waterproof.
5. In case the equipment seems to be defective, the warranty holder (the “Claimant”) must do the following to make a claim:
 - (a) Contact the dealer or service centre where the equipment was purchased and make the claim. Alternatively, the Claimant can make the claim to a dealer or service centre found at www.sleipnergrou.com. The Claimant must present a detailed written statement of the nature and circumstances of the defect, to the best of the Claimant’s knowledge, including product identification and serial nbr., the date and place of purchase and the name and address of the installer. Proof of purchase date should be included with the claim, to verify that the warranty period has not expired;
 - (b) Make the equipment available for troubleshooting and repair, with direct and workable access, including dismantling of furnishings or similar, if any, either at the premises of the Warrantor or an authorised service representative approved by the Warrantor. Equipment can only be returned to the Warrantor or an authorised service representative for repair following a pre-approval by the Warrantor’s Help Desk and if so, with the Return Authorisation Number visible postage/shipping prepaid and at the expense of the Claimant.
6. Examination and handling of the warranty claim:
 - (a) If upon the Warrantor’s or authorised service Representative’s examination, the defect is determined to result from defective material or workmanship in the warranty period, the equipment will be repaired or replaced at the Warrantor’s option without charge, and returned to the Purchaser at the Warrantor’s expense. If, on the other hand, the claim is determined to result from circumstances such as described in section 4 above or a result of wear and tear exceeding that for which the equipment is intended (e.g. commercial use of equipment intended for leisure use), the costs for the troubleshooting and repair shall be borne by the Claimant;
 - (b) No refund of the purchase price will be granted to the Claimant, unless the Warrantor is unable to remedy the defect after having a reasonable number of opportunities to do so. In the event that attempts to remedy the defect have failed, the Claimant may claim a refund of the purchase price, provided that the Claimant submits a statement in writing from a professional boating equipment supplier that the installation instructions of the Installation and Operation Manual have been complied with and that the defect remains.
7. Warranty service shall be performed only by the Warrantor, or an authorised service representative, and any attempt to remedy the defect by anyone else shall render this warranty void.
8. No other warranty is given beyond those described above, implied or otherwise, including any implied warranty of merchantability, fitness for a particular purpose other than the purpose for which the equipment is intended, and any other obligations on the part of the Warrantor or its employees and representatives.
9. There shall be no responsibility or liability whatsoever on the part of the Warrantor or its employees and representatives based on this Warranty for injury to any person or persons, or damage to property, loss of income or profit, or any other incidental, consequential or resulting damage or cost claimed to have been incurred through the use or sale of the equipment, including any possible failure or malfunction of the equipment or damages arising from collision with other vessels or objects.
10. This warranty gives you specific legal rights, and you may also have other rights which vary from country to country.

Patents

At Sleipner we continually reinvest to develop and offer the latest technology in marine advancements. To see the many unique designs we have patented visit our website www.sleipnergrou.com/patents

© **Sleipner Group**, All rights reserved
The information given in the document
was right at the time it was published.
However, Sleipner Group cannot
accept liability for any inaccuracies or
omissions it may contain. Continuous
product improvement may change the
product specifications without notice.
Therefore, Sleipner Group cannot accept
liability for any possible differences
between product and document.

**Register your product and learn more
at www.sleipnergroun.com**



SLEIPNER AS

P.O. Box 519

N-1612 Fredrikstad

Norway

www.sleipnergroun.com

Made in Norway

