

MODÈLE:
65000074

Haut-parleurs double gamme complète de 4"
Complètement étanche
Pour une utilisation maritime ou automobile
Cône en PP avec bord en caoutchouc
Panier en plastique ABS moulé
Puissance maximale: 60 watts
Aimant: 3,4 oz
Réponse en fréquence: 100Hz-18Khz
Impédance: 4 Ohms
Sensibilité: 89 dB
Dimensions (mm): D124, d97, H49, h35

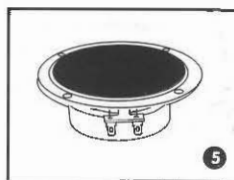

GUIDE D'INSTALLATION

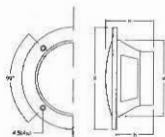
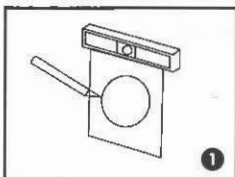

Coupez la cloison sèche.
Remarque: autorisez toujours au moins un demi-pouce entre un mur goujon et la découpe du haut-parleur ou les languettes de verrouillage ne pourront pas pour pivoter en place.

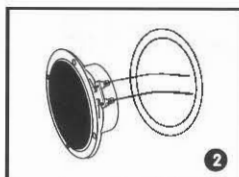

Connectez les fils des haut-parleurs à le haut-parleur.

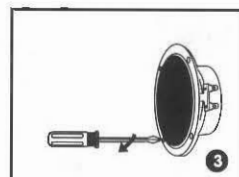

Visser chacun des quatre Vis à tête.
Les languettes de verrouillage pivoteront dans placez et fixez l'appareil à la surface arrière de la cloison sèche.
Mettez les bandes adhésives pour fixer la grille.

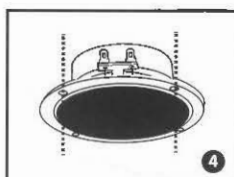

Remettez la grille métallique en place.

MODELO:
65000074

Alto-falantes Dual Full Range de 4"
Completamente impermeável
Pera uso marítimo ou automóvel
PP Cone com Borda de Borracha
Cesta de plástico ABS moldado
Potência máxima: 60 watts
Ímã: 3,4 onças
Resposta de frequência: 100Hz-18Khz
Impedância: 4 Ohms
Sensibilidade: 89 dB
Dimensões (mm): D124, d97, H49, h35

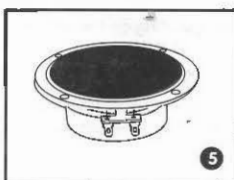
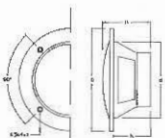

GUIA DE INSTALAÇÃO

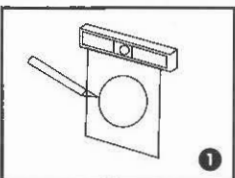

Corte o drywall.
Nota: Sempre permita pelo menos meia polegada entre uma parede pino e recorte do alto-falante ou as guias de bloqueio não serão capazes para girar no lugar.

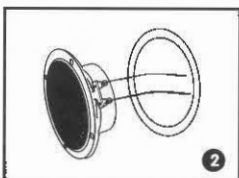

Conecte os fios do alto-falante ao o alto-falante.

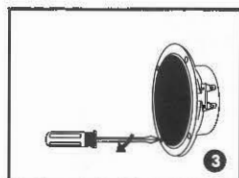

Aparafuse cada um dos quatro Parafusos de cabeça Philips.
as guias de travamento irão girar para dentro coloque a prenda a unidade para a superfície traseira do drywall.
Coloque as tiras de adesivo para prenda a grade.

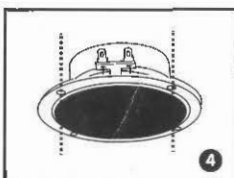

Substitua a grade de metal.

MODÈLE:
65000074

Lors de la mise sous tension de l'amplificateur, alors qu'il est connecté à un haut-parleur, vous entendrez une tonalité confirmant que l'appareil est allumé.
Pour connecter un périphérique Bluetooth, recherchez le nom de périphérique IMNASA et utilisez le mot de passe situé au bas de la feuille pour vous connecter.

Lors de la lecture de musique, l'entrée audio Bluetooth aura priorité sur l'entrée analogique située sur l'appareil. Cela signifie que si l'analogique l'entrée est utilisée et un périphérique Bluetooth est connecté, l'amplificateur utilisera alors le périphérique Bluetooth comme source. Si le Bluetooth l'appareil est déconnecté et l'appareil analogique est toujours connecté, l'amplificateur utilisera alors l'appareil analogique comme source.

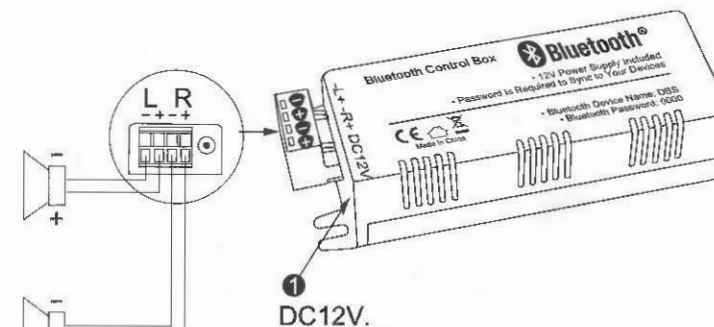

DC12V.

Nom du périphérique Bluetooth: IMNASA
Mot de passe Bluetooth: 0000

MODELO:
65000074

Ao ligar o amplificador, enquanto ele estiver conectado a um alto-falante, você ouvirá um tom que confirma que o dispositivo está ligado.
Para conectar um dispositivo Bluetooth, procure o nome do dispositivo IMNASA e use a senha localizada na parte inferior da folha para conectar.

Ao reproduzir música, a entrada de áudio Bluetooth terá prioridade sobre a entrada analógica localizada no dispositivo. Isso significa que se o analógico a entrada estiver sendo usada e um dispositivo Bluetooth estiver conectado, o amplificador usará o dispositivo Bluetooth como fonte. Se o Bluetooth dispositivo for desconectado e o dispositivo analógico ainda estiver conectado, o amplificador usará o dispositivo analógico como fonte.

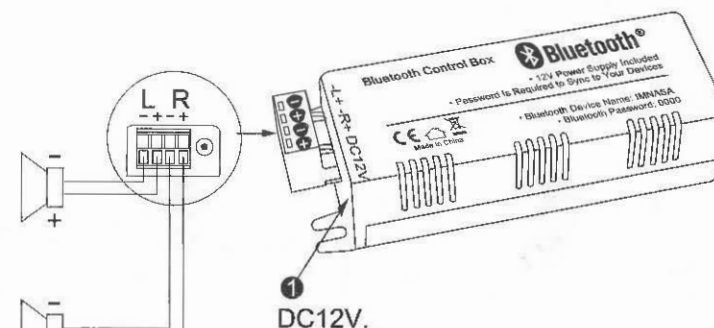

DC12V.

Nome do dispositivo Bluetooth: IMNASA
Senha Bluetooth: 0000

MODELO:
65000074

Altavoces duales de rango completo de 4" *Completamente impermeable*
Para uso marino o autom3vii
Cono de PP con borde de goma
Cesta de pl1stico ABS moldeada
Potencia m1xima: 60 vatios
Im1n: 3.4 oz
Respuesta de frecuencia: 100Hz-18Khz
Impedancia: 4 ohmios
Sensibilidad: 89 dB
Dimensiones (mm): D124, d97, H49, h35

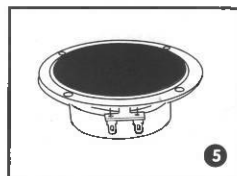
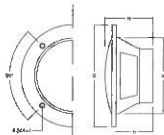

GUÍA DE INSTALACIÓN

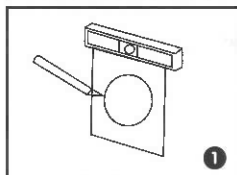

Corta el panel de yeso.
Nota: permítele siempre al menos media pulgada entre una pared, el perno prisionero y el corte del altavoz o las pestañas de bloqueo no podr1n girar en su lugar.

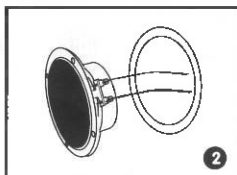

Conecta los cables de los altavoces al altavoz.

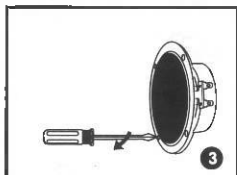

Atornilla cada uno de los cuatro tornillos. Las pestañas de bloqueo girar1n. Coloque y asegure la unidad a la superficie trasera del panel de yeso. Coloque las tiras de adhesivo. Asegure la rejilla.

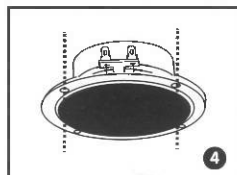

Reemplaza la rejilla met1lica.

MODEL:
65000074

4" Dual Full Range Speakers *Completely Waterproof*
For Marine or Car use
PP Cone with Rubber Edge
Molded ABS Plastic Basket
Max Power: 60 Watts
Magnet: 3.4 Oz
Frequency Response: 100Hz-18Khz
Impedance: 4 Ohms
Sensitivity: 89 dB
Dimensions (mm): D124, d97, H49, h35

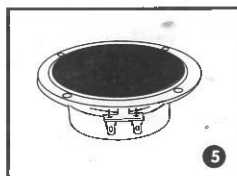
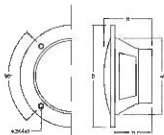

INSTALLATION GUIDE

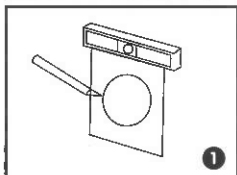

Cut the drywall.
Note: Always allow at least one-half inch between a wall stud and the speaker cutout or the locking tabs will not be able to swivel into place.

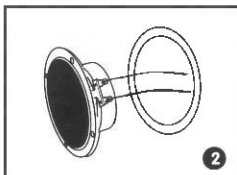

Connect the speaker wires to the speaker.

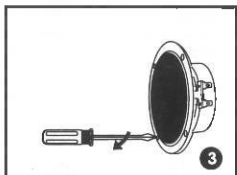

Screw down each of the four Phillips head screws. The locking tabs will swivel into place and secure the unit to the rear surface of the drywall. Put in the strips of adhesive to secure the grille.

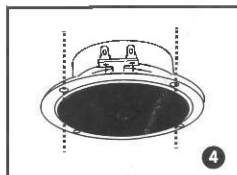

Replace the metal grille.

MODELO:
65000074

Al encender el amplificador, mientras est1 conectado a un altavoz, escuchar1 un tono que confirma que el dispositivo est1 encendido. Para conectar un dispositivo Bluetooth, busque el nombre del dispositivo IMNASA y use la contrasea ubicada en la parte inferior de la hoja para conectarse.

Al reproducir m1sica, la entrada de audio Bluetooth tendr1 prioridad sobre la entrada anal3gica ubicada en el dispositivo. Esto significa que si el an1logo se est1 utilizando la entrada y hay un dispositivo Bluetooth conectado, el amplificador utilizar1 el dispositivo Bluetooth como fuente. Si el Bluetooth dispositivo est1 desconectado y el dispositivo anal3gico todav1a est1 conectado, el amplificador utilizar1 el dispositivo anal3gico como fuente.

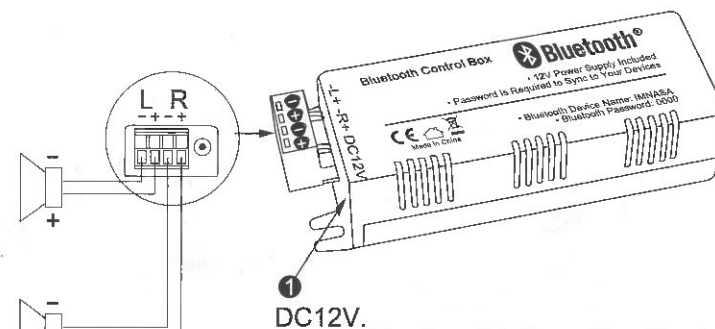

DC12V.

Nombre del dispositivo Bluetooth: IMNASA
Contrasea de Bluetooth: 0000

MODEL:
65000074

When powering on the amplifier, while it is connected to a speaker, you will hear a tone which confirms the device is on. To connect a Bluetooth device, search for the device name IMNASA and use the password located at the bottom of the sheet to connect.

When playing music, the Bluetooth audio input will take priority over the analog input located on the device. This means if the analog input is being used, and a Bluetooth device is connected, the amplifier will then use the Bluetooth device as the source. If the Bluetooth device is disconnected, and the analog device is still connected, the amplifier will then use the analog device as the source.

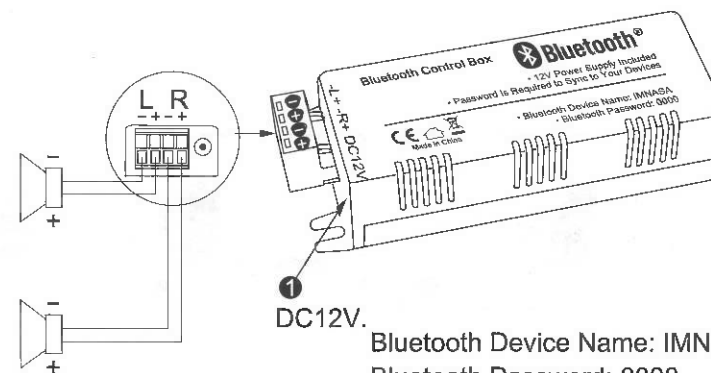

DC12V.

Bluetooth Device Name: IMNASA
Bluetooth Password: 0000